

SKIPPER

DL21

Installation Manual

Dual axis Doppler Speed Log System (SOG+STW) for vessels >50.000GT.

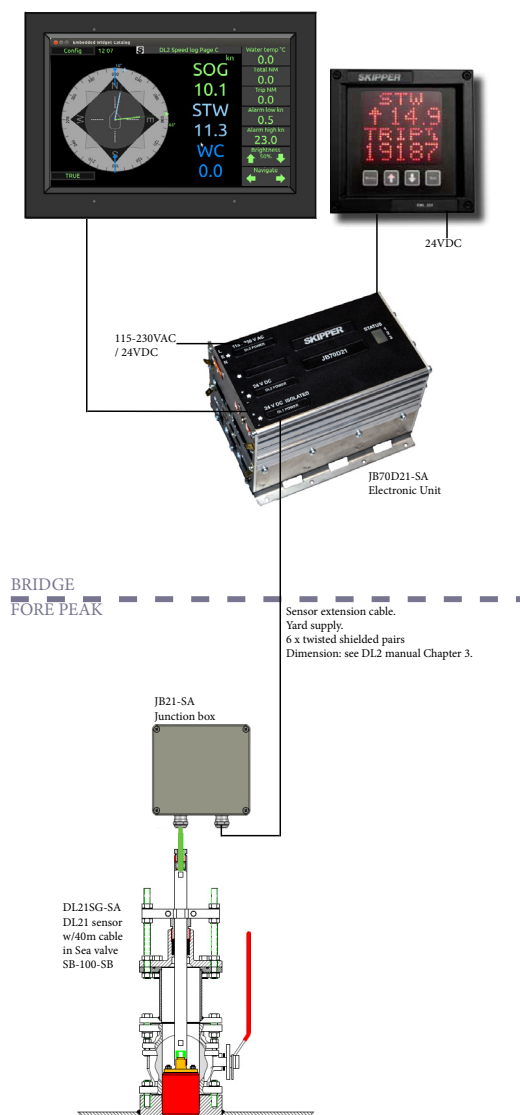

SKIPPER Electronics AS
Enebakkveien 150
P. O. Box 151, Manglerud
0612 Oslo, Norway
www.skipper.no

Telephone: +47 23 30 22 70
E-mail: support@skipper.no
Co. reg. no: NO-965378847-MVA

Document no: **DM-M006-SA**
Rev: 2017
For software ver 1.0.16
Date: 2020-05-04



DL21***DUAL AXIS DOPPLER SPEED LOG SYSTEM***

INSTALLATION MANUAL

Weitergabe sowie vervielfältigung dieser unterlage, verwertung und mitteilung ihres Inhaltes nicht gestattet, soweit nicht ausdrücklich zugestanden. Zuwiderhandlungen verpflichten zu schadenersatz.

Toute communication ou reproduction de ce document, toute Exploitation ou communication de ou son contenu sont interdites, sauf autorisation expresse. Tout manquement à cette règle est illicite et expose son auteur au versement de dommages et intérêts.

Copying of this document, and giving it to others and the use or communication of contents thereof, are forbidden without express authority. Offenders are liable to the payment of damages.

Sin nuestra expresa autorización, queda terminantemente prohibida la reproducción total o parcial de este documento, así como su uso indebido y/o su exhibición o comunicación a terceros. De los infractores se exigirá el correspondiente resarcimiento de daños y perjuicios.

COMMUNICATING WITH US

If you need more information, support or other assistance from us, do not hesitate to contact us:

SKIPPER Electronics AS
P. O. Box 151, Manglerud
NO-0612 Oslo
Norway

Phone: (+47) 23 30 22 70, Fax: (+47) 23 30 22 71
E-mail: support@skipper.no

SOFTWARE UPDATES AND TECHNICAL SUPPORT

Find us on the internet: www.skipper.no

YOUR FEEDBACK IS APPRECIATED

If you find errors, misspellings or poorly explained sections in this document, please do not hesitate to contact us at:

support@skipper.no

CONTENTS

TERMINOLOGY	5
Terms used in this manual.....	5
CHAPTER 1: GETTING STARTED.....	7
Overview DL21.....	7
Optional items DL21.....	8
Items Not supplied by SKIPPER.....	9
Power supply requirements.....	9
CHAPTER 2: HARDWARE MOUNTING	10
Placement of the Operator unit.....	10
Placement of the electronic unit.....	11
Placement of JB21 Junction box.....	12
Placement of repeaters.....	12
Placement of the sea valve.....	13
Placement of the Sensor in sea valve.....	14
CHAPTER 3: WIRING.....	17
Clamping the cables.....	17
CU-M001-21-SB Operator unit wiring.....	18
JB70D21-SA Electronic Unit Wiring.....	19
Connectors supplied with JB70D2.....	20
SENSOR CONNECTION DL21.....	21
NMEA CONNECTION.....	22
NMEA CONNECTION.....	23
AUX/Alarm CONNECTION J2.....	24
Additional NMEA, Aux and analog Out.....	24
Yard supplied extension cable from sensor to JB70 Electronic unit.....	25
The junction box (JB12)/splice.....	25
CHAPTER 4: SETUP PROCEDURE	28
CONFIG.....	29
CU-M001 setup.....	30
JB70D2 setup.....	31
DL2 setup.....	32
Reset.....	35
Software options.....	36
Communications setup (NMEA/UDP).....	38
NMEA.....	38
LAN UDP.....	38
NMEA sentences received.....	40
NMEA sentences transmitted.....	41
Alarm/Alert setup.....	42
Setup AUX.....	46
System Diagnostics.....	47
Available options in the diagnostic page.....	47
Error messages.....	47
Saving and locking.....	48
Hardware options.....	49
CHAPTER 6: SOLVING PROBLEMS.....	50
Software upgrade.....	50
APPENDIX 1: INSTALLATION DRAWINGS.....	51
APPENDIX 2: DATA SHEETS.....	56
APPENDIX 4: COMMISIONING CHECKLIST.....	59

TERMINOLOGY

TERMS USED IN THIS MANUAL

Units

Unless otherwise stated, all values shown on the display are as follows:

Speed	Knots
Distance (Vessel)	Nautical miles
Depth	Meters
Tilt	° Degrees
Temperature	° Centigrade
Rotation	Degrees per minute
Heading	Degrees

Abbreviations

In addition, the following symbols are used





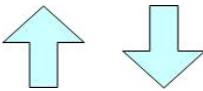
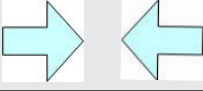

WT	Water track
BT	Bottom track
STW	Speed through water
SOG	Speed over ground
Trip	Text for trip/total
ECDIS	Electronic Chart Display and Information System
INS	Inertial Navigation System
VDR	Voyage Data Recorder
ROT	Rotation from Gyro
GYRO	Gyroscopic heading / rotation sensor
HDG	Heading
DL2	2 Axis Doppler Log (with speed over bottom and Speed through water)
DL1	1 Axis speed through water sensor (part of DL21 system)
DL21	A system with combined DL1 and DL2 in the same housings
UDP	User Datagram Protocol.
SFI	System function Id
LAN	Local Area Network

Symbols

In addition, the following symbols are used

	Indicating that the information presented is partly from the GPS input, and therefore not from this sensor. (Outputs may show invalid data in this mode)
	Symbolising that the data presented is longitudinal (forward or backwards)
	Symbolising the data is transversal (port or starboard)

	Symbolising the resultant speed direction
-----------------------------------------------------------------------------------	-------------------------------------------

	Alarm active. Unacknowledged (flashing)
	Alarm active. Silenced (flashing)
	Alarm active. Acknowledged
	Alarm active - Responsibility transferred alarm
	Alarm rectified - Unacknowledged
	Simulator mode - The system is using a simulator to generate the speed and depth
	Option - Mute mode. The system has a sync option activated and is currently being muted (No acoustics)

CHAPTER 1: GETTING STARTED

OVERVIEW DL21

The DL21 Doppler speed log is a Dual STW and SOG Navigational Doppler Speed log system. The new DL21 Speed Log is designed for ships over 50.000 GT with simultaneous and independent measurement of speed through water and speed over ground.

The DL21 is a DL1 (single axis STW) + DL2 (Dual axis STW + SOG), built into 1 sensor housing, 1 electronic unit and 2 Display units.

The system fulfills all class and type regulations based on MED B (wheelmark) and is manufactured in Norway under stringent production controls.

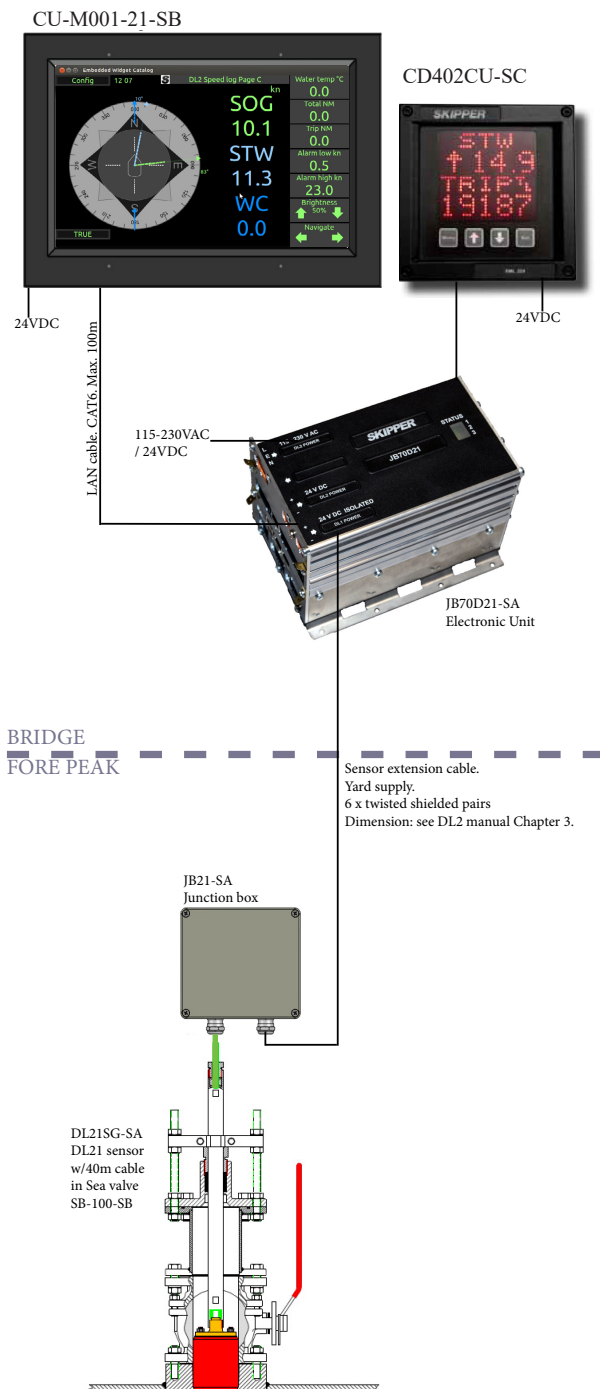

The DL21 system consist of:

- 2 x Operator units.
 - CU-M001-21-SB for DL2
 - CD402CU-SC for DL1

1 x Dual Electronic Unit
JB70D21-SA Electronic unit

1 x Junction box
JB21-SA
(Optional for extension of 40 m sensor cable)

- 1 x Sensor DL21SG-SA
 - 1 x (STW) Single axis + 1 x (STW + SOG) Dual axis sensor in one housing.
 - Fits into SB-100-XX/DB-100-XX sea valves

OPTIONAL ITEMS DL21

The following items are optional SKIPPER supplied items.

- Speed Repeater
- External dimmer
- LAN switch

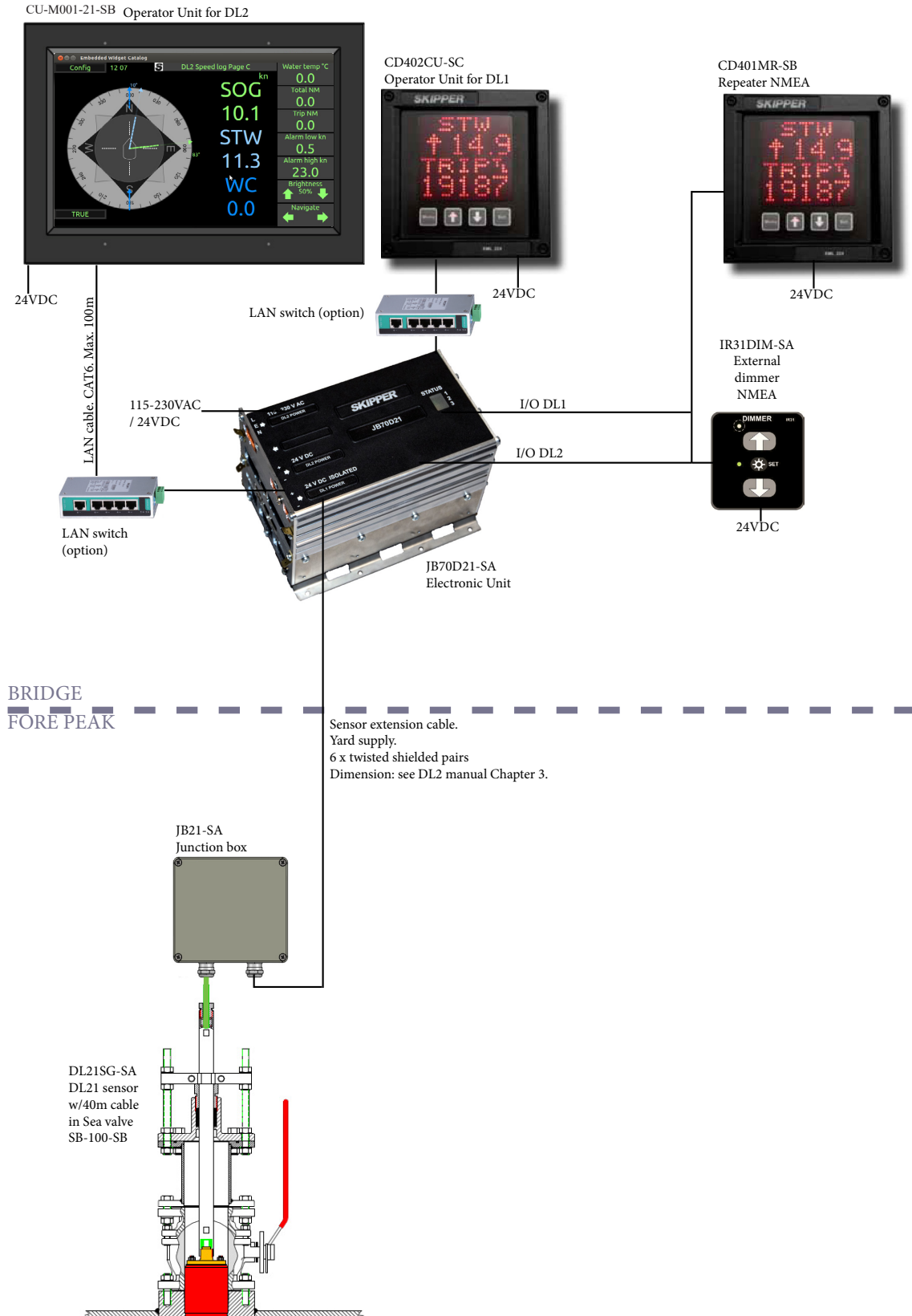

ITEMS NOT SUPPLIED BY SKIPPER

The following items are not SKIPPER supplied:

- LAN cable (minimum CAT6) from Operator unit to Electronic unit.
- The sensor is manufactured with a 40m cable. The cable may be cut or extended. Extension cable is 6 pairs with individual screens. See chapter 3 for lengths and dimensions.

POWER SUPPLY REQUIREMENTS

The JB70D21-SB power supply includes separate power for DL1 and DL2

DL2:

- CU-M001-21-SA. Operator Unit. 24V DC. Max 10 W, Typical 6 W.
- JB70D21-SA. Electronic unit (DL2 Power): 24V DC and/or 115/230V AC. Max 60 W typical 15 W.

DL1:

- CD402CU-SA. Operator Unit. 24V DC. Max 10 W, Typical 6 W.
- JB70D21-SA. Electronic unit (DL1 Power): 24V DC. Max 20 W.

There are no power switches on the CD402CU-SA, CU-M001-21-SB or JB70D21-SA.

The separate power inputs should be including a manual circuit breaker.

There are no input fuse on the CD402CU-SA, CU-M001-21-SB or JB70D21-SA.

The power input should be including a fuse rated for 100 % - 200 % of max power installed components.

Example:

Two separate 24V supplies for DL1 and DL2.

Each 24V supply should have a 3A slow blow fuse.

Optional items power supply requirement:

- CD401MR-SB repeater. 24V DC. Max 10 W, Typical 6 W.
- IR31DIM-SA. External dimmer: 24V DC
- LAN switch: 24VDC

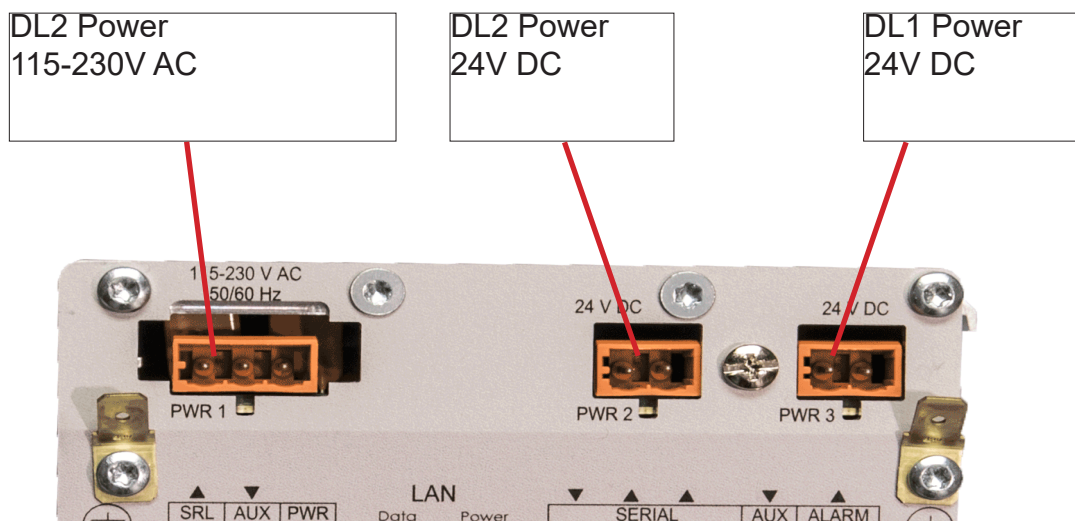

CHAPTER 2: HARDWARE MOUNTING



PLACEMENT OF THE OPERATOR UNIT

The operator unit is placed on the bridge.

Some standards require some operations of the unit to be available from 'standing position'. These operations are available from the operator unit and multi-repeaters if both input and output are connected.

Dimensional drawings are found in Appendix 1.

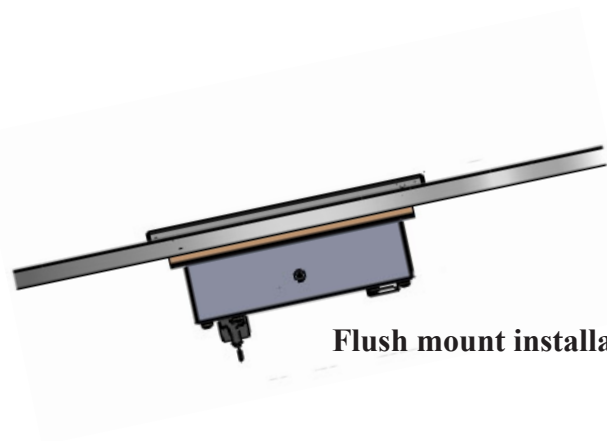

PLACEMENT OF THE ELECTRONIC UNIT

The electronic unit can be installed on a DIN rail or directly screwed onto the wall.

All parts of the system are connected to the electronic unit.

There are no buttons (like ON/OFF) in the electronic unit. Access is only required for service purpose. Placement is typically in or near the bridge where the interfaced systems are available, but no nearer than 0.5 m to the GYRO heading sensor. IP rating: IP20.

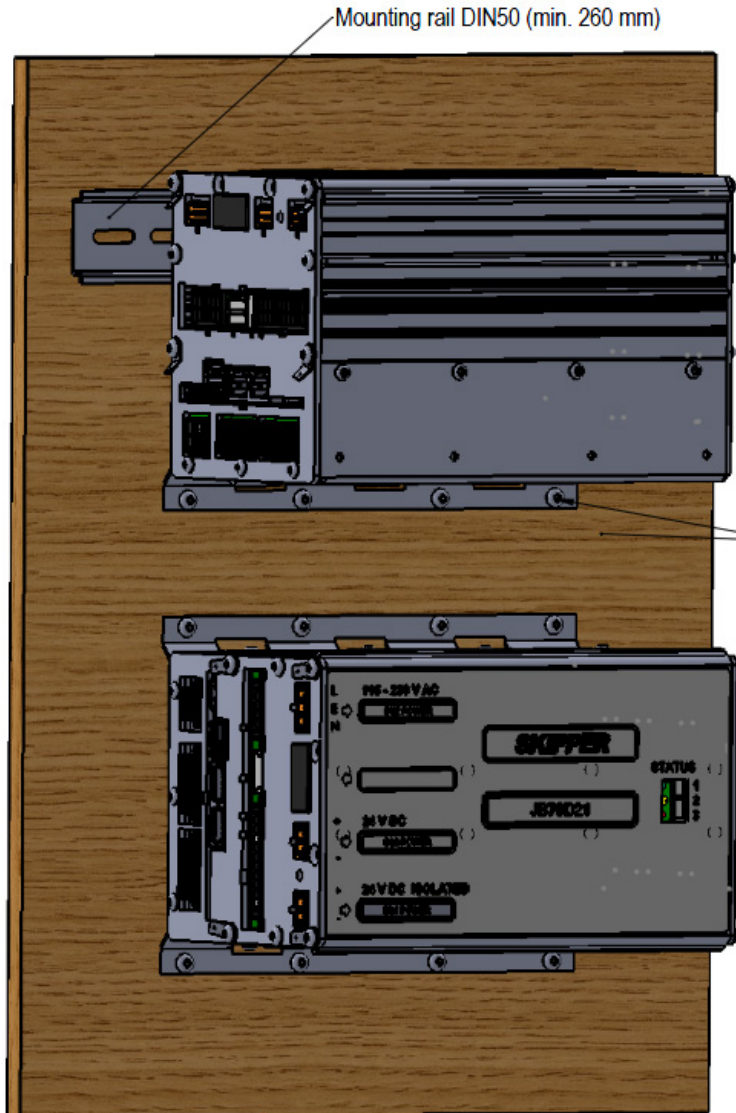

PLACEMENT OF JB21 JUNCTION BOX

The junction box JB21 is an option for connecting sensor cable to a yard supplied extension cable (See chapter 3).

It is placed in a dry place within reach of the 40m sensor cable.

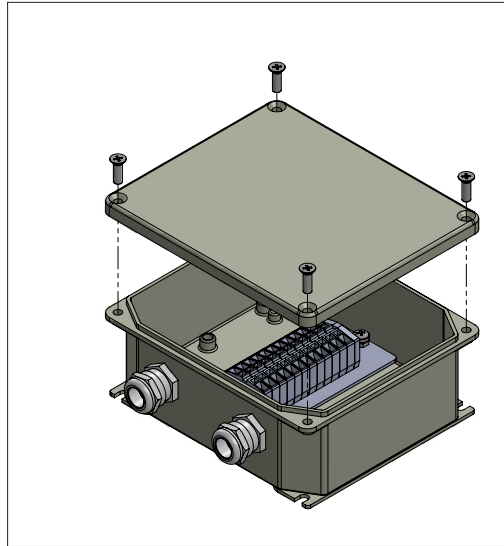

PLACEMENT OF REPEATERS

Repeaters are typically installed on the overhead console and/or the bridge wings. These can be routed using NMEA signals. These require a local +24 V DC supply. Please note that STW NMEA output from DL1 part and SOG NMEA is from DL2 part.

PLACEMENT OF THE SEA VALVE

Mounting instructions for the sea valve is available from the SKIPPER web site in separate manual depending on the chosen type. When placing the speed log sensor, consider the following moments:

- Free sight to the bottom (it should be possible to draw a cone of ± 45 degrees from the sensor to the bottom).
- The active face of speed sensor must be in parallel to the horizontal line, max offset $\pm 1^\circ$.
- Do not mount transducers aft of bow thruster, propeller outlets or aft of other hull installations (such as outlets, vents or other protruding details) that may create aeration or turbulence.
- It is necessary to select a part of the hull that is submerged and free from turbulence and aeration under all load and speed conditions, and to avoid positions where air is trapped in heavy weather.
- If a flat, horizontal section is not available for transducer fitting, the shipyard must construct a suitable bed. Welding seams in this area and forward should be smoothed and rounded off in order not to create turbulence or aeration and maintain a laminar waterflow at all speed ranges of the vessel.
- Select an area that is acoustically quiet. The DL2 operates at frequencies between 270 kHz and 284 kHz. The DL1 between 710-720kHz.

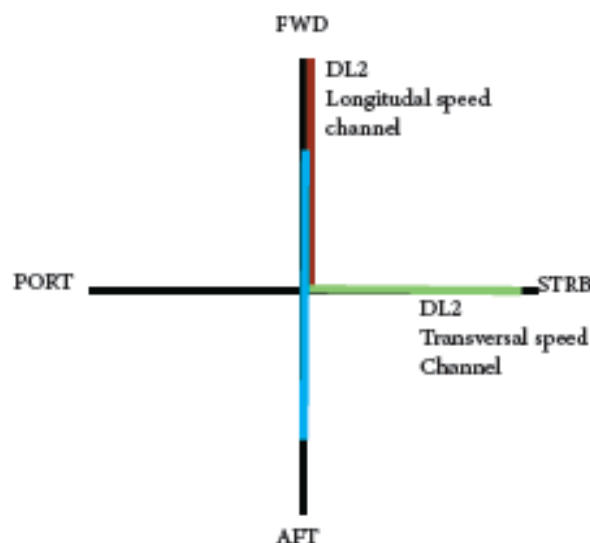

There are 4 acoustic channels in DL21

DL1 has 2 channels (Blue forward and blue aft)

DL2 has 2 channels (Brown forward and Green starboard).

The acoustic signal is sent in a 30deg angle from vertical.

A tilt sensor internally inside the DL21SG-SA sensor is used to compensate for vessel movement.

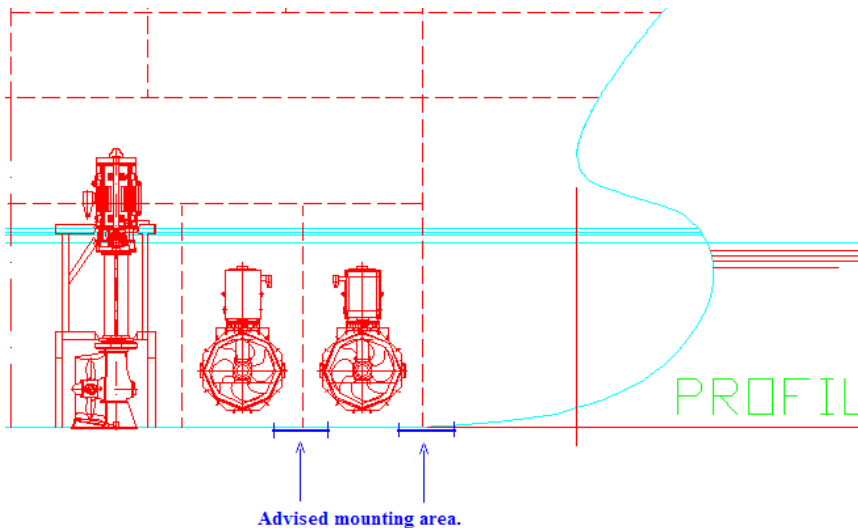

The generally best placement on larger vessels is in the front region of the vessel just behind the bulbous bow (see fig above). This area is generally designed such that the bubbles are pushed to either side of the bulb, leaving a clear area under the bulb and just behind. The sensor is installed in a sea valve in order to service the sensor (clean or replace) without docking the vessel.

It is recommended (but not required) to install the sea valve in a dry area, like a bow thruster room. This will enable easy cable access to junction box and additionally increase the lifetime of the sea valve.

PLACEMENT OF THE SENSOR IN SEA VALVE

The sensor DL21 is installed into sea valve 100mm for single bottom SB-100-SB or double bottom DB-100-SB.

Please see sea valve manual for installation procedure.

Manuals available as downloads from www.skipper.no

The sensor includes 40m moulded in cable. The cable is 11 mm in outer diameter with a bending radius of 56 mm. The cable can be cut or extended if required

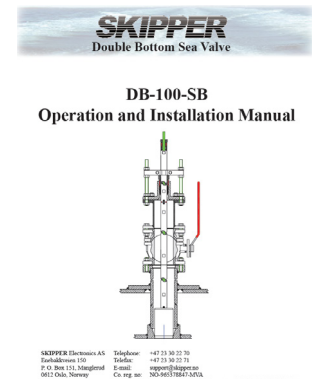
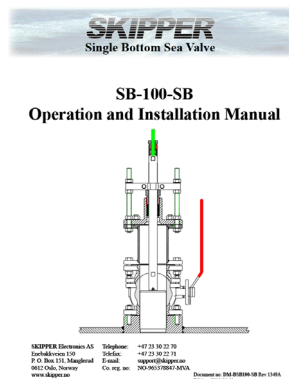

NOTE

During physical installation of sensor into sea valve please make special care of the following points:

- Sensor to be lowered completely into bottom flange making sensor head flush with outer hull.
- Sensor forward direction to be aligned +/-10deg. (Fine adjust by software in calibration page)
- Clamping unit nuts and nut M50 to be tighten to secure sensor position.

Sensor lowered flush with outer hull.

Pictures showing lowering procedure in sea valve SB-100-SB.

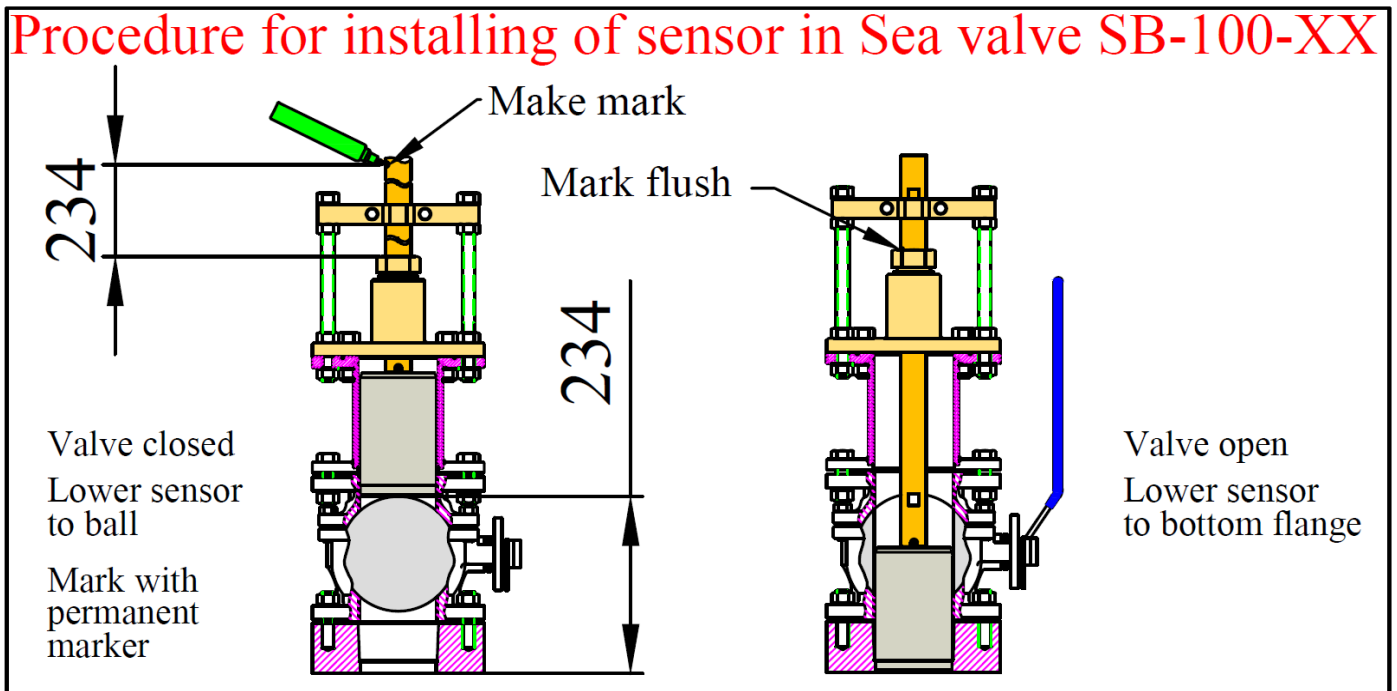

Sensor forward direction.

It is important to align sensor forward direction.

Pictures showing forward direction alignment in sea valve SB-100-SB.

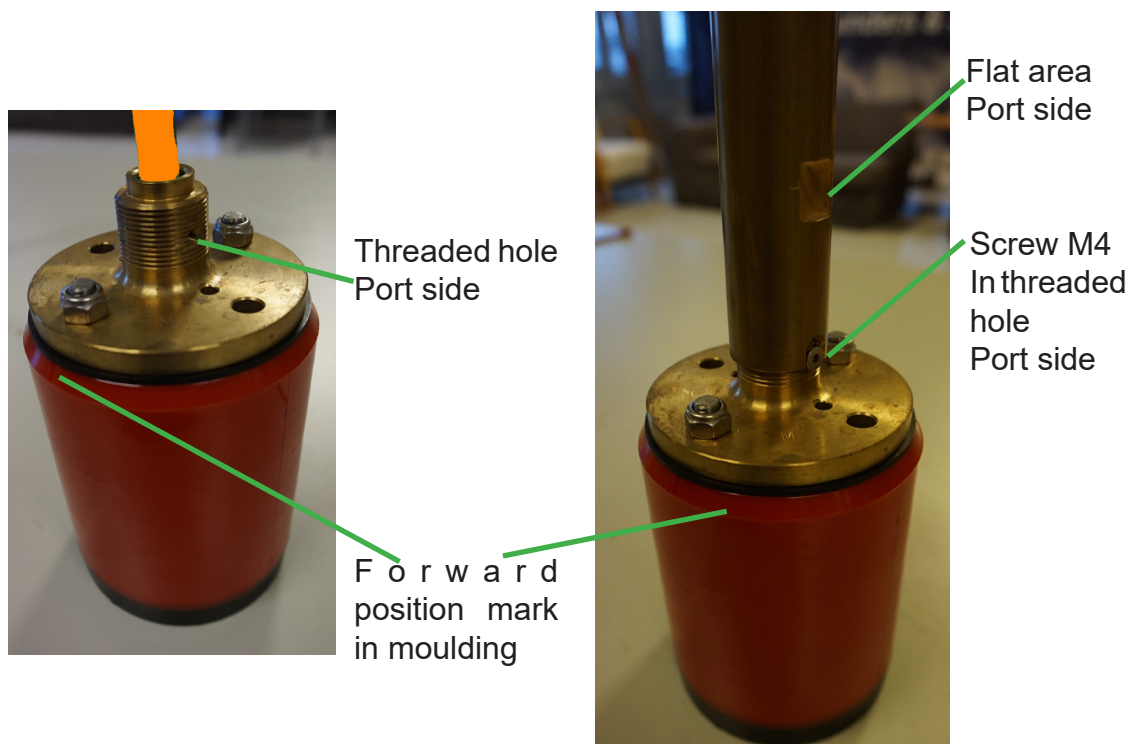

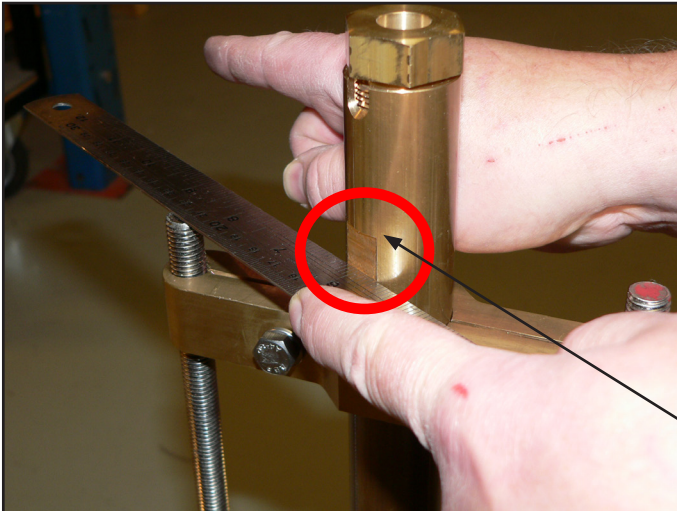

A flat object points fore/aft.

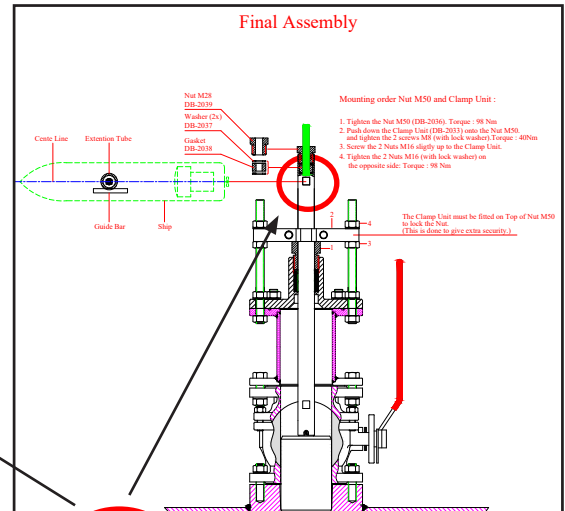

The flat side should be on the port side.

Secure sensor by tightening clamping unit and nut M50

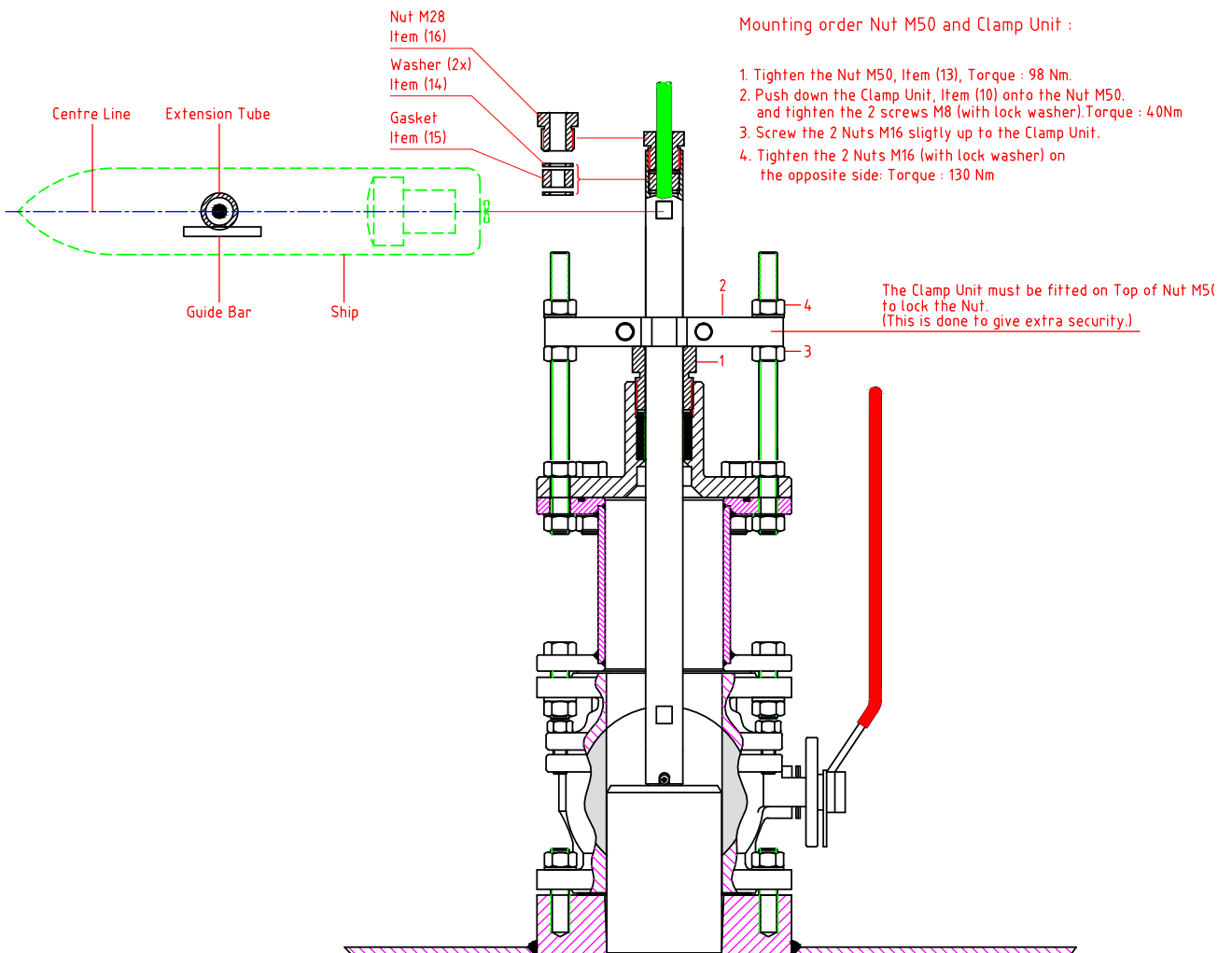

CHAPTER 3: WIRING

Two separate 24VDC supplies are required

The JB70D21-21-SA does not contain a physical switch and should be connected to a circuit breaker. Power may be nominal 24V DC (No more than 32V DC) and/or 115-220V AC. Max 60W typical 15W. The AC input is an optional back up for DL2 part of JB70D21-SA only.

There are no input fuse on the CU-M001-21-SB or JB70D21-SA.

The power input should be including a fuse rated for 100% - 200% of max power installed components. Example: A 24V DC to power both CU-M001-21-SB and JB70D21-SA should have a 3A slow blow fuse.



CLAMPING THE CABLES

Cables should be connected to WAGO connector, leaving approximately 3 cm of tail. They should be stripped with 6-7 mm of metal showing and these should be connected as in the diagram above. A small screwdriver with blade size approx 3.5 mm can be used. WAGO part no 210-719 is ideal for this use.

Outer shields should be collected and grounded in a ground stud on the edge of the cabinet. The outer insulation should be cable tied to the plastic handle of the connector, and securely anchored nearby. The plugs when refitted, must be installed such that their clips are fully in the up position.



CU-M001-21-SB OPERATOR UNIT WIRING

The operator unit has 2 connectors.

1 LAN connector for communication with Electronic unit.

2: WAGO connector CN1 for 24V power. Max 10W, Typical 6W.

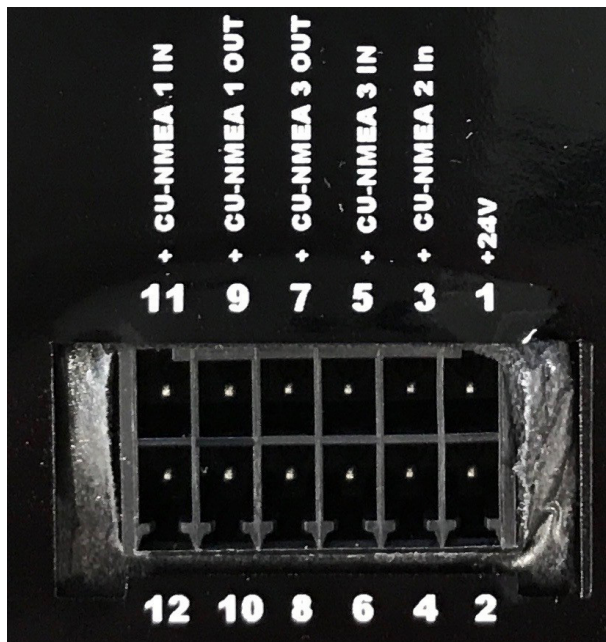
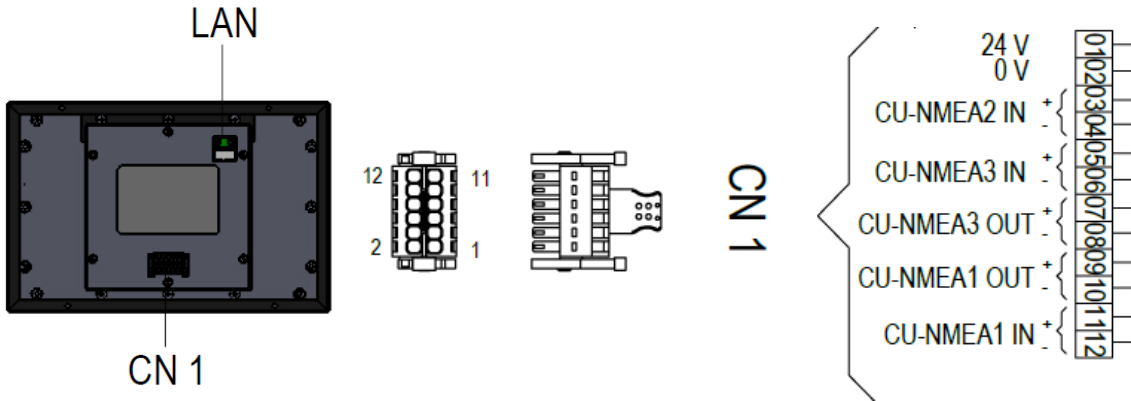

Note:
 CU-NMEA only in use for parallel systems. See appendix 4.
 Standard NMEA I/O on
 JB70D2-SA

Items supplied with CU-M001-21-SB

1 x ZZN-01120.
 Connector Female w/ejectors 6x2 pole, black. (CN 1)

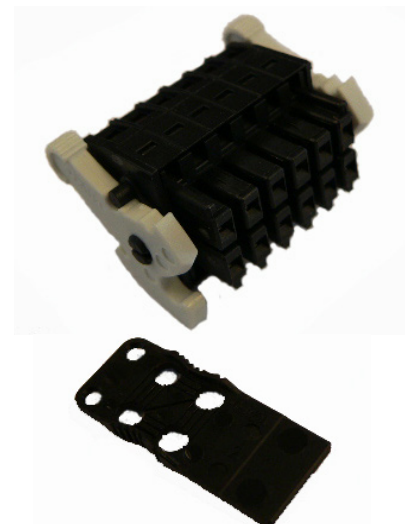

1 x ZZN-01123. Strain relief plate, 6x2 pole, width 11 mm. (CN 1)

JB70D21-SA ELECTRONIC UNIT WIRING

The JB70D21-XX does not contain a physical switch (only software) and should be connected to a circuit breaker for removal of power.

The DL2 is powered from nominal 24VDC (Max 32VDC) and/or 115-230V AC.

The DL1 is powered from 24V DC Isolated input.

For wiring of DL1 Operator unit (CD402) please see "Installation manual DL1" DM-M004.

For wiring of DL2 Operator unit (CU-M001) please see "Installation manual DL2" DM-M002.

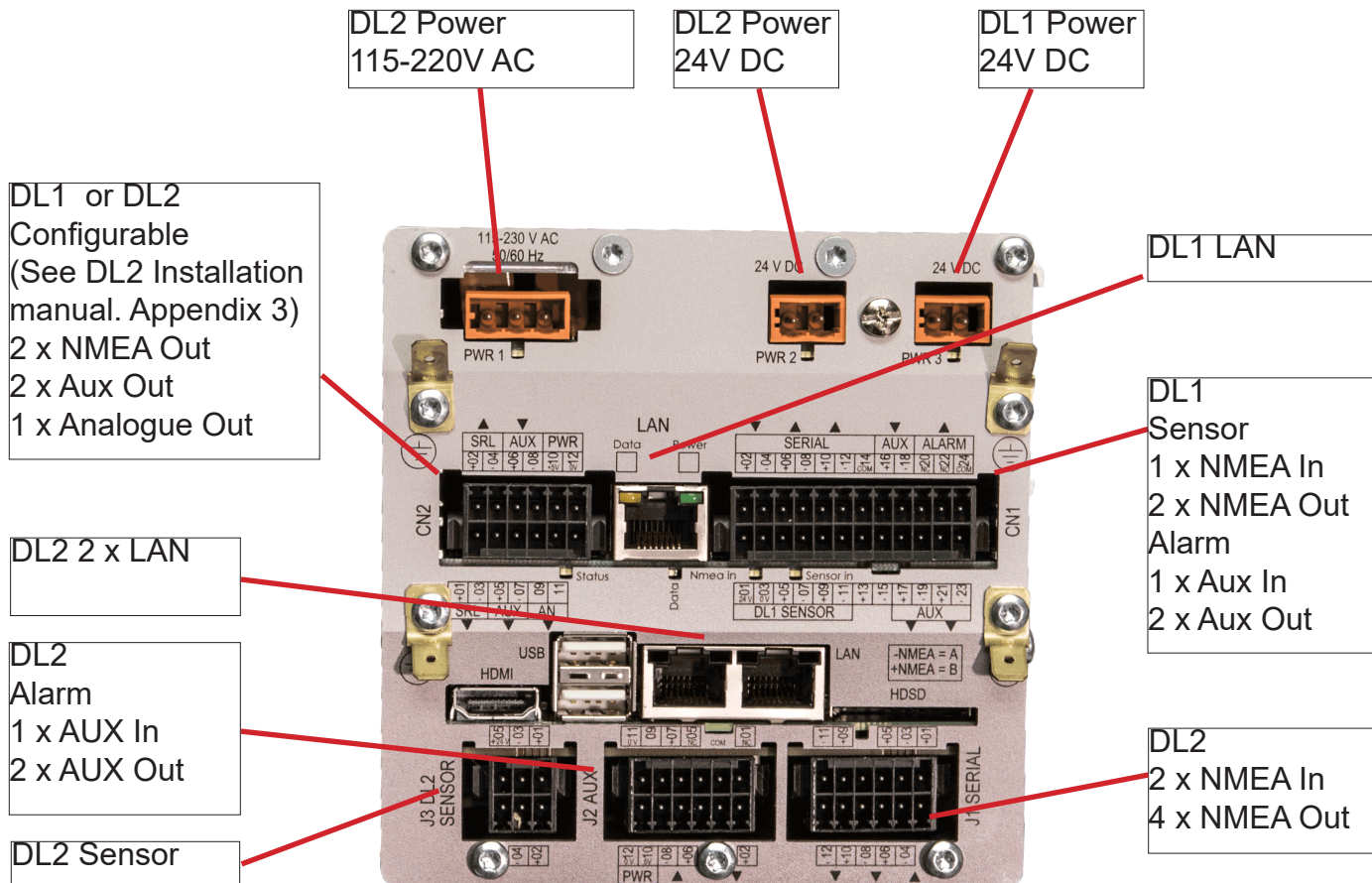
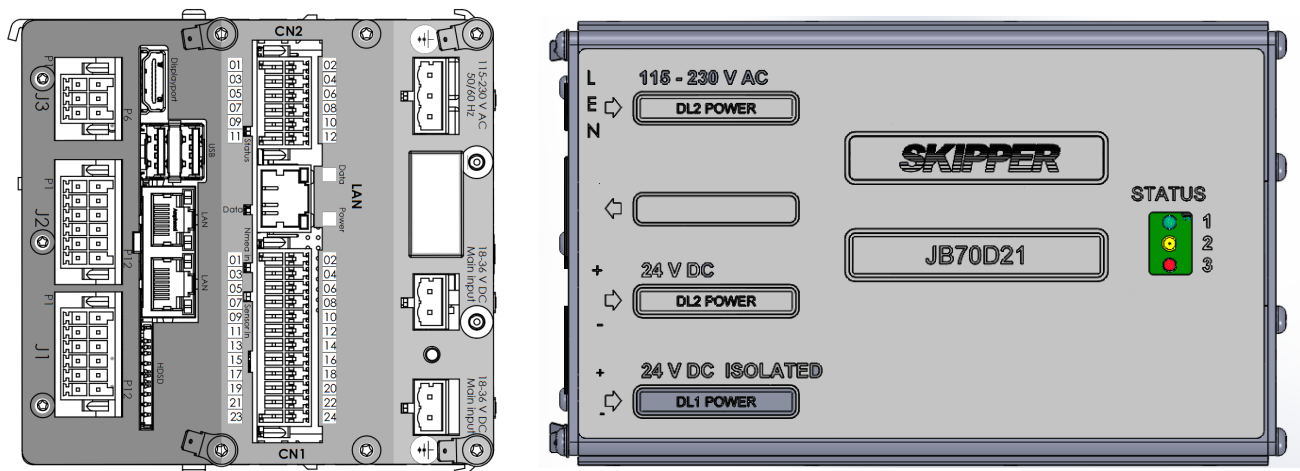

CONNECTORS SUPPLIED WITH JB70D2



ZZN-01126 Relief Housing,
3 pole snap-on.
WAGO: 232-633



ZZN-01124 Plug, Female 2
pole, 231-302_032-000



ZZN-01136 Plug, Female
3 pole with locking levers,
231-303/037-000

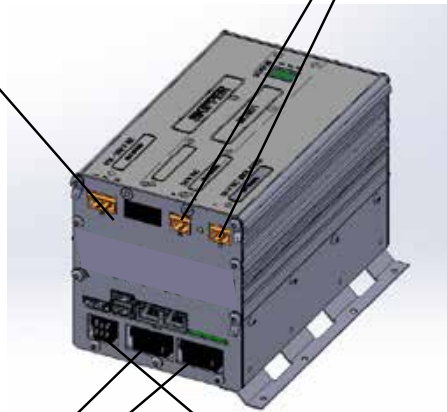

ZZN-01120 Connector Fe-
male w ejectors 6x2 pole, black
WAGO 713-1106/037-000



ZZN-01130 Connector, Fe-
male w/ejectors 3x2 pole, black
WAGO 713-1103/037-000



ZZN-01123 Strain relief
plate, 6x2 pole, width 11 mm
WAGO 713-126



ZZN-01123 Strain relief
plate, 6x2 pole, width 11 mm
WAGO 713-126

SENSOR CONNECTION DL21

The sensor is two separate sensors. Each powered separately and communicating separately with JB70D21-SA Connector J3(DL2) and CN1 (DL1).

The cable screen is connected to screen on sensor side and does not need to be grounded at JB70D2-SA side, if the system has instability problems grounding at the JB70 unit may help. .

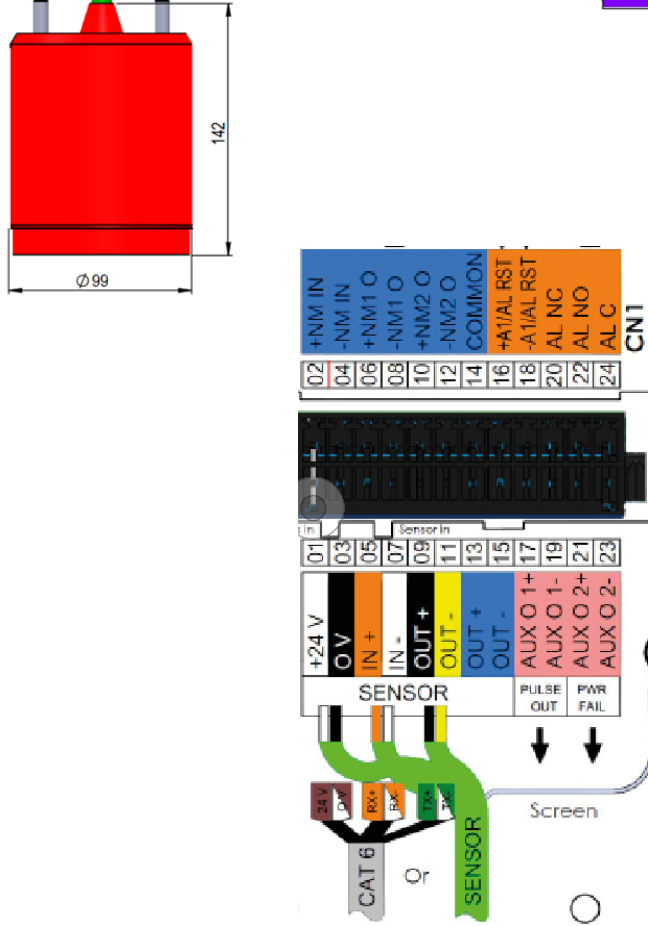
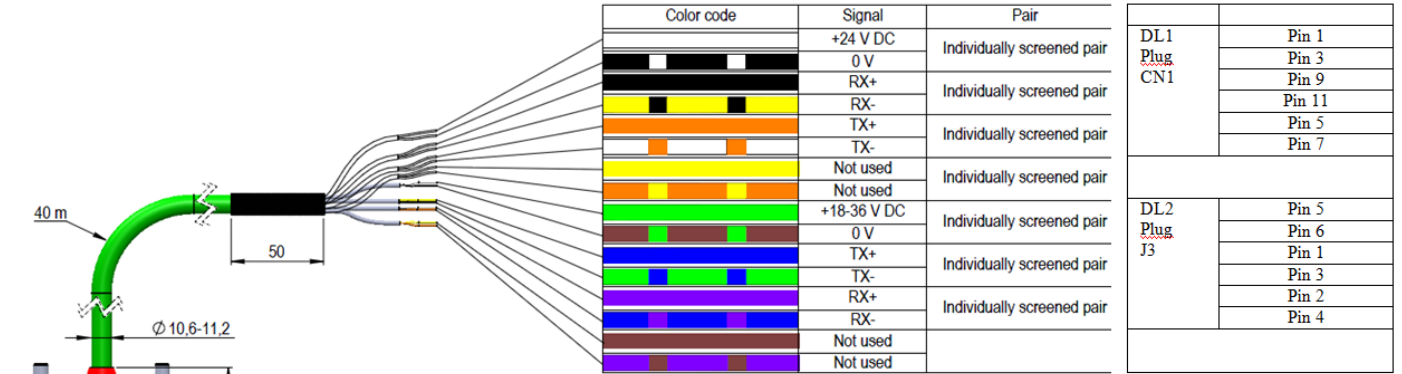

CN1 Pin1

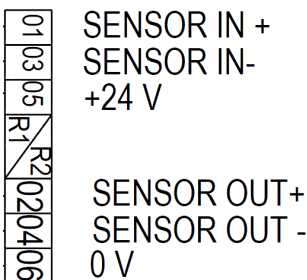
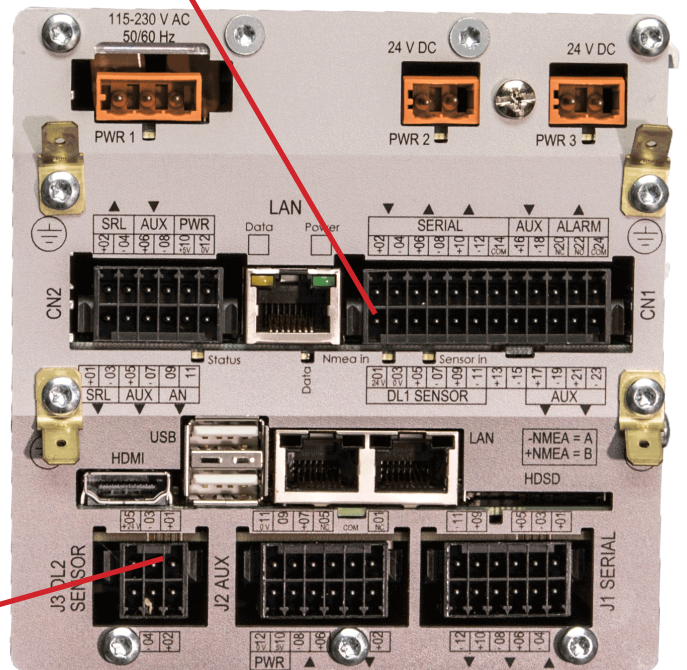

J3

J3 Pin1

NMEA CONNECTION

The DL21 is in fact two individual speed log systems. When connecting I/O to external devices it is important to consider the alternative methods.

Recommended alternative 1

DL1 sending STW in VHW (or VBW) sentence. Trip in VLW sentence

DL2 sending SOG in VBW sentence.

This alternative is making a clean border between DL1 as a STW and DL2 as SOG speed log. It will however require a receiver with 2 NMEA inputs.

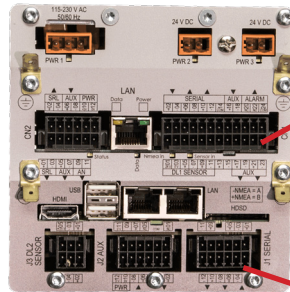

DL1 NMEA out
VHW + VLW



DL2 NMEA out
VBW



Recommended alternative 2

DL2 sending SOG, STW in VBWX sentence. Trip in

This alternative is possible because DL2 is receiving STW and trip information internally in the system from DL1. The VBWX sentence is a proprietary SKIPPER sentence used only by DL2 in a DL21 system to transmit STW, SOG and Trip from one NMEA output

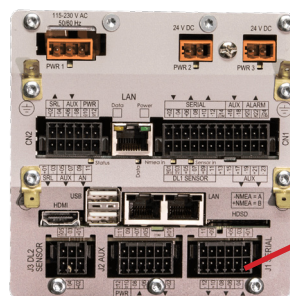

DL2 NMEA out
VBWX+VLW



NMEA CONNECTION

SOG may be transmitted from the DL2 VBW sentence. DL2 has standard 2 NMEA Inputs and 2 Outputs.

Each output is dual and makes total of 4 outputs.

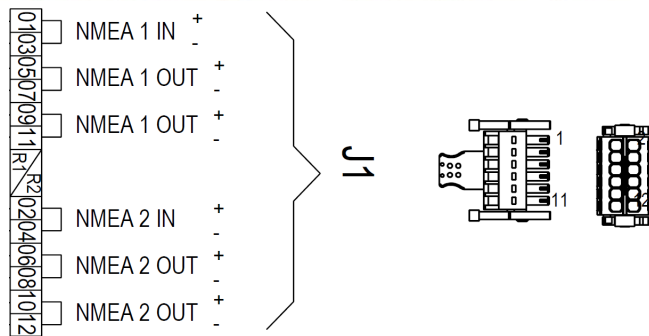
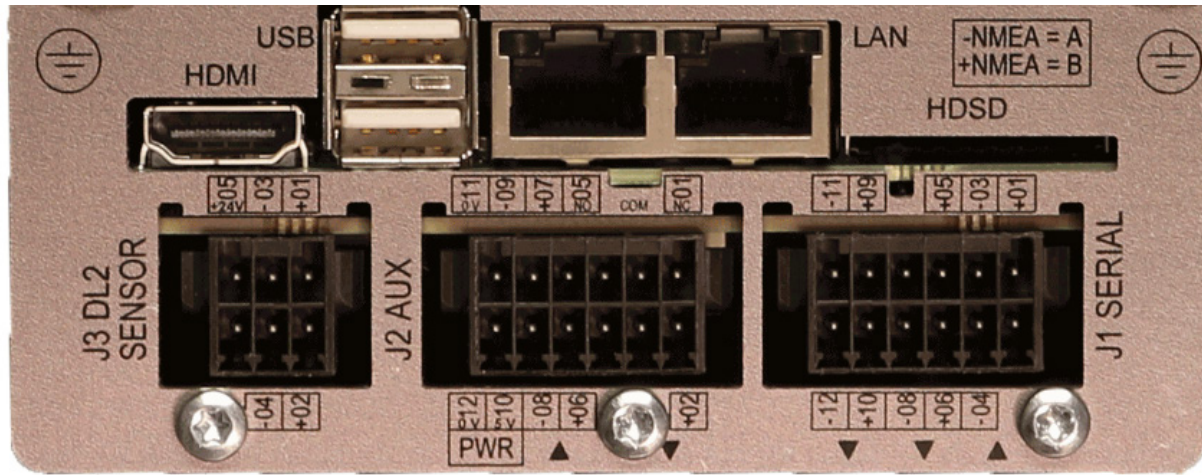

If high speed protocols are to be used (IEC61162-2) the communication common (COM) can be connected to pins 11 or 12 of J2

AUX/ALARM CONNECTION J2

The DL2 has standard

- Alarm relé
- 1 x Aux In. (default set as "Alarm reset")
- 2 x Aux Out.

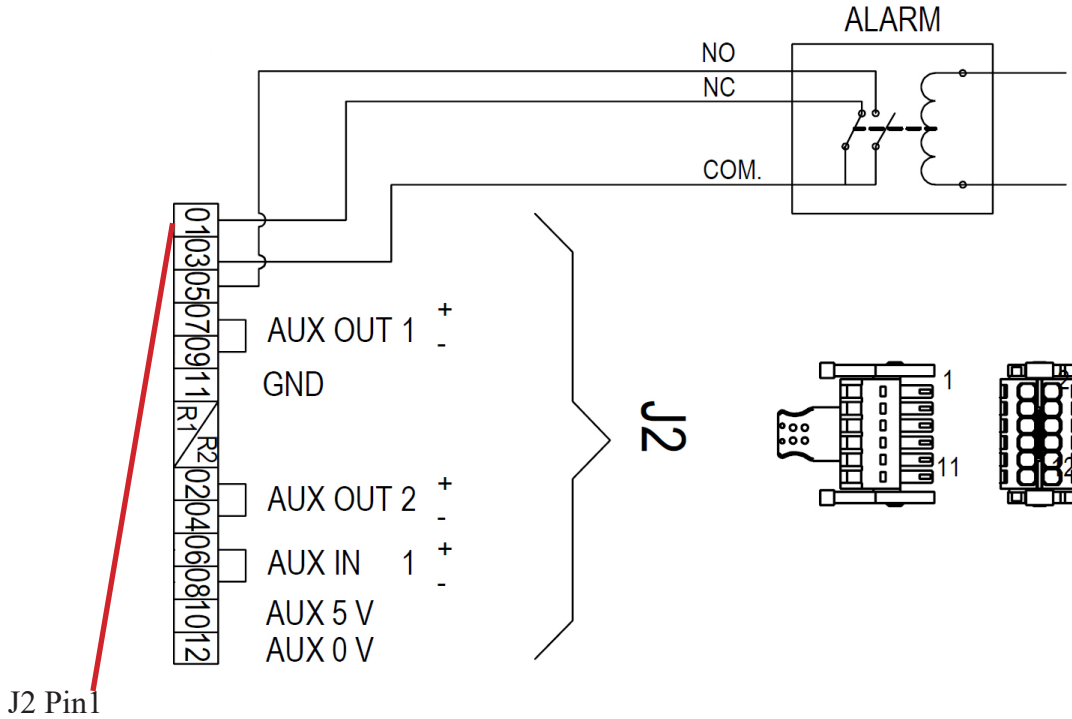

J2 Pin1

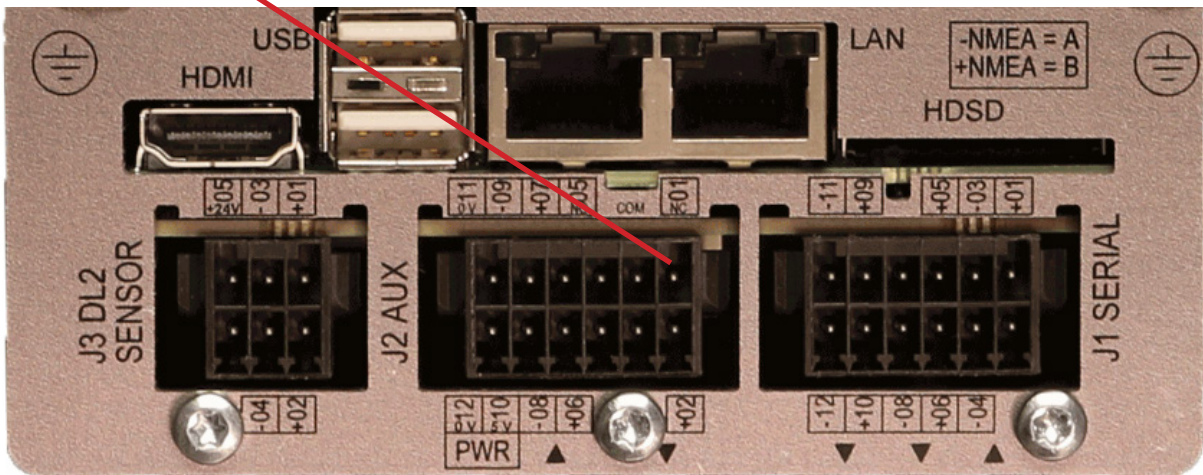

ADDITIONAL NMEA, AUX AND ANALOG OUT

An optional Multi Extension PCB is required for additional NMEA, additional Aux or analog output. See Appendix 3.

YARDSUPPLIEDEXTENSIONCABLEFROMSENSORTOJB70ELECTRONICUNIT.

Any screened 3 or 4 twisted pair cable can be used as long as the loop resistance (measured by twisting the pair together at one end and measuring the resistance) is less than 8.6 ohms (worst case).

Example1:

What kind of cable do I need for 300m distance from sensor to Electronic unit?

300m cable (0.3km). Loop length $0.3 \times 2 = 0.6$ km. $8.6 / 0.6 = 14.3$ Ohms/km

Use a cable with maximum 60 Ohm conductor DC resistance per km.

AWG15 / 1.5mms has resistance of 10.4 ohm /km

Example2

I have a CAT7 cable. Spec says 70 Ohm conductor DC resistance per km. How long distance from sensor to Electronic unit can I use this cable?

$8.6 / 70 = 0.122$ km. $0.122 \text{km} / 2 = 60.1$ m maximum length.

THE JUNCTION BOX (JB12)/SPLICE

The JB12 Junction box may be used as a terminal between sensor cable and an extension cable. Dimensional drawing see Appendix 1.

All individual screens of sensor cable to be connected to the outer screen of the CAT7 extension cable.

Do not ground screens to JB12 chassis.

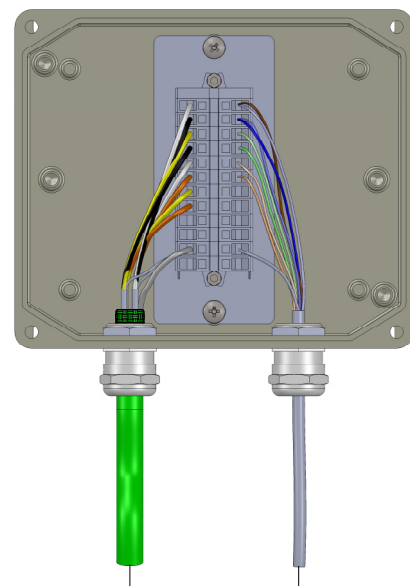
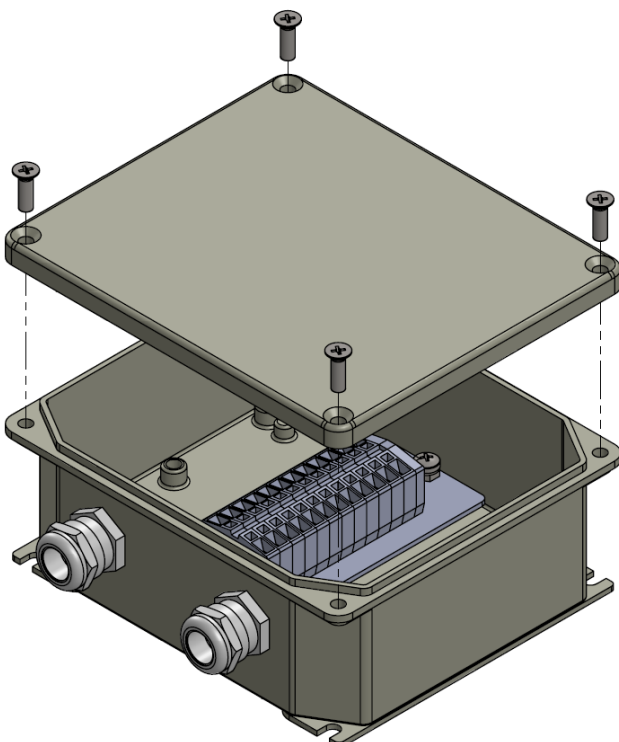

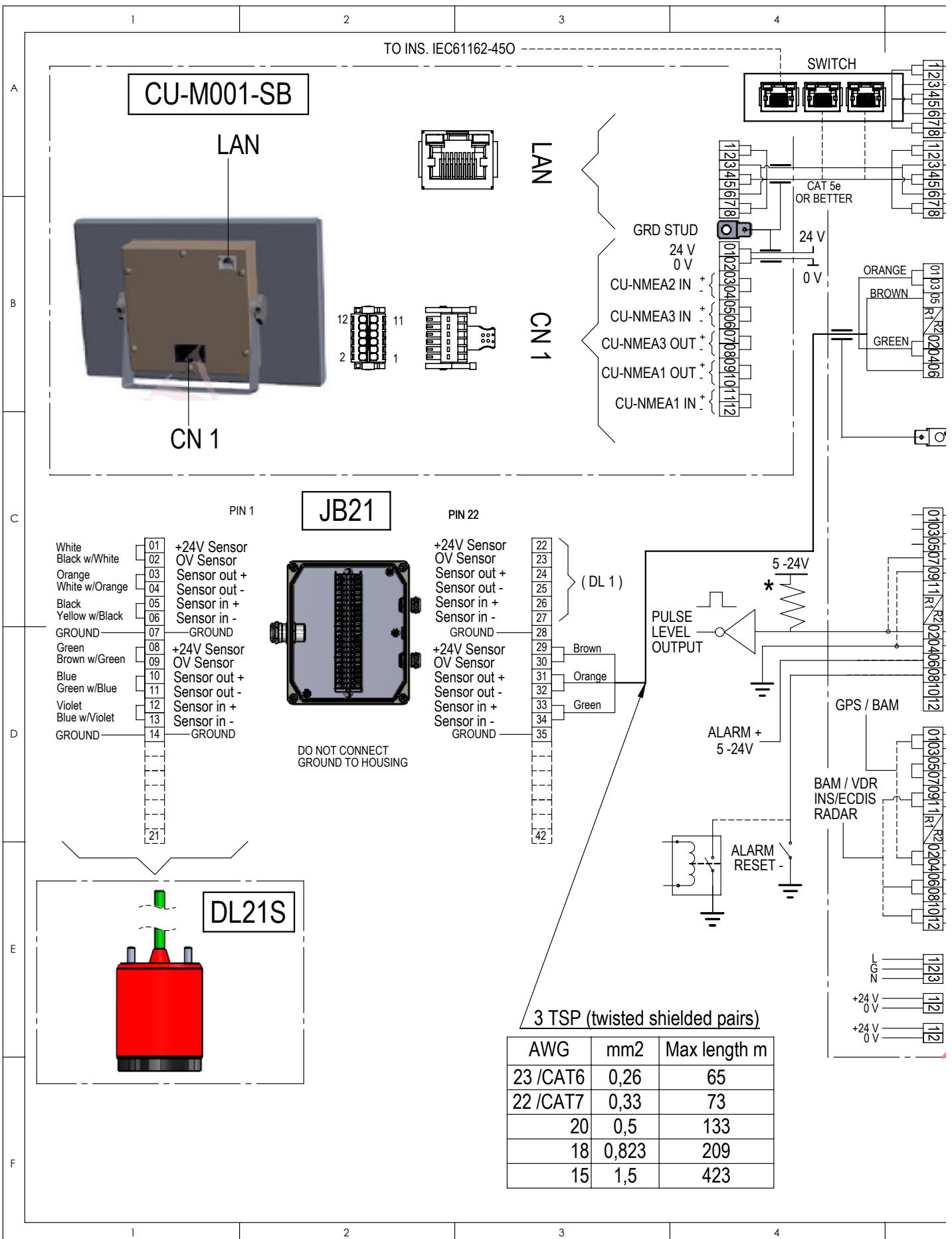

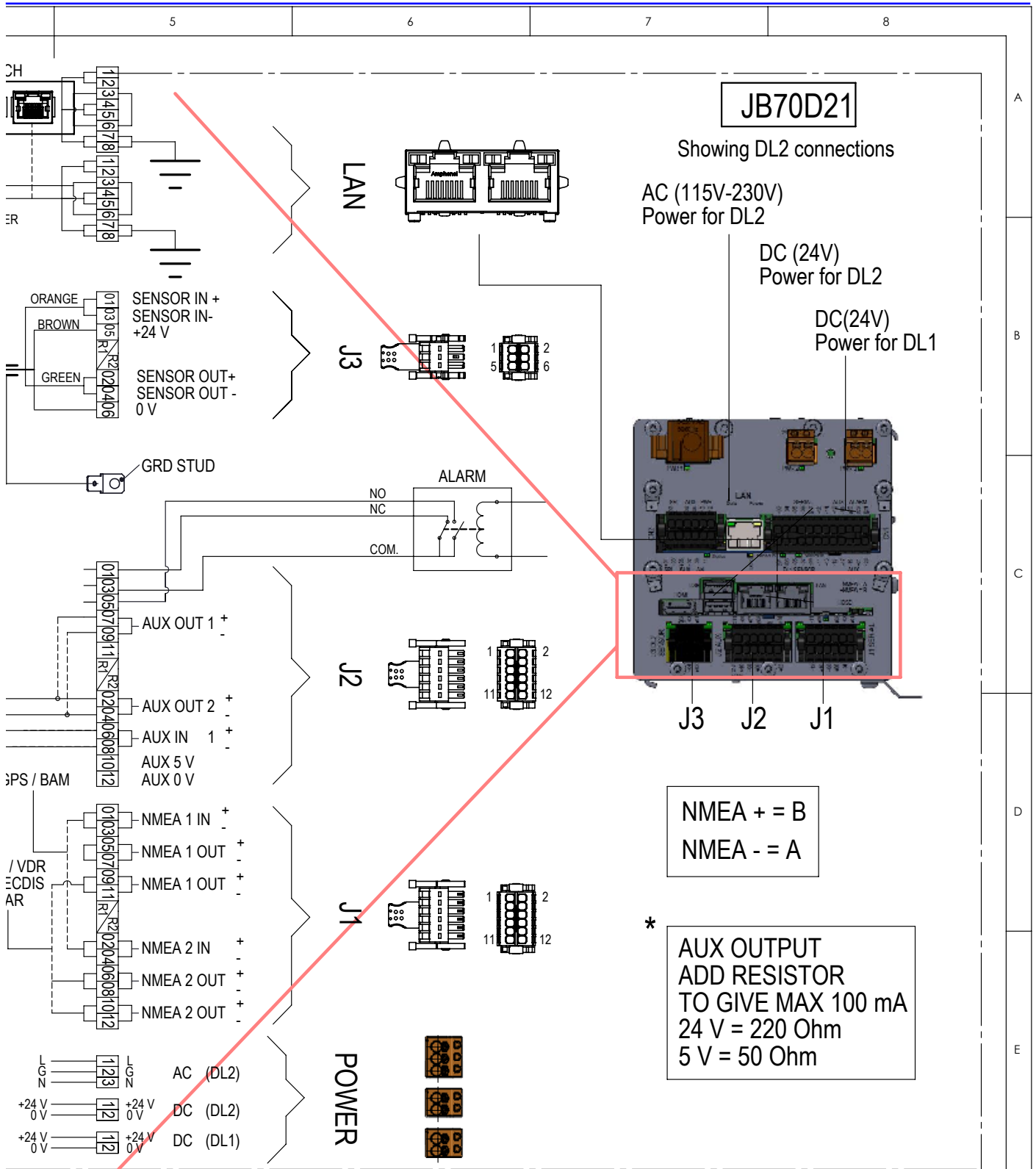

CN	2018.09.28 ST CU-M001-S8 connector change. Changed value on AWG table								
Designed by - date	Checked by	Approved by - date	Material						
ST 2015.04.20	GT	GT 2018.09.28	Name Wiring diagram for DL21 Multi Showing DL2 connections						
			Drwg. no. CD-2038				Revision 01		
			Gen. tolerance ISO2768m	Eur. projection	Scale	Edition date 2018.09.28	Sheet 1 of 2		

CHAPTER 4: SETUP PROCEDURE

Setup of communication JB70D2-SA to CU-M001-SB

The communication between operator unit and Electronic unit is following IEC61162-450 lightweight ethernet standard.

This standard allows the network to be used for the distribution and control of sensor systems such as the DL2. These communicate using proprietary NMEA type messages on this multicast (UDP) system. The system will exert a maximum load on the network of 20 kB/s (kilobyte per second), and will tolerate a data traffic up to 20Mbit/s (Megabit per second)

An advantage of this method of communicating is that it becomes simple to have more than 1 display unit on the same system. Instead of (or as well as) repeaters, the user can have as many control units as they wish. These are activated by pairing the units to the electronic unit. In the case of INS bridges, the main bridge conning unit can be used as a control unit as well or instead of the screen (with approval).

The following parameters must be set on both units before communication is established:

- IP address
- SFI
- Paired SFI (only for Operator unit CU-M001-SB)
- Group

IP Address: The IP address of the system should not clash with any other system within the network. Regulations state that the IP address range. During setup, it may be necessary to change the IP to fit into your local network.

SFI (System Function ID): Each device has its own identifier (SFI) and the systems can then identify who they are and who they are talking to. These should be unique within a vessel.

Paired SFI: Each Operator unit CU-M001-SB device needs to know which system it is part of. By entering the SFI of the JB70D2-SA the system pairs itself.

It is possible to have multiple screens to a single JB70D2-SA unit. All screens will work in parallel.

Group: There are 16 groups available for the system to be part of. It is important that the group is the same on all communicating devices.

NOTE: The following procedure will take you through the setup using the operator unit CU-M001. It is important to change the JB70D2-SA group before the CU-M001-SB group otherwise you will lose connection

The setting of IP address, SFI, Paired SFI and Group on JB70D2-SA is also accessible from SKIPPER service software by connecting a PC to the second LAN port or via a LAN switch.

SKIPPER service software is available in download folder on www.skipper.no

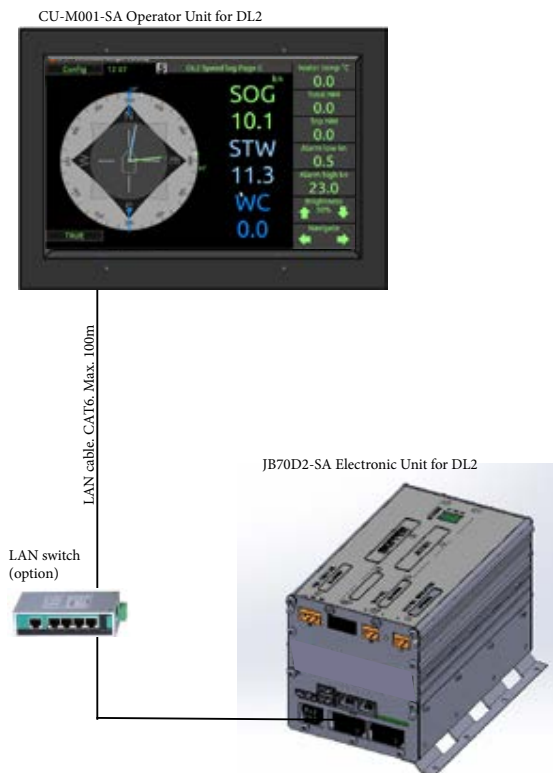

CONFIG

Setup pages are accessed by pressing “CONFIG”



First, the Operator unit CU-M001-SA must be connected to the main Electronic Unit JB70D2-SA. To do this enter the “CU-M001 SETUP” page.

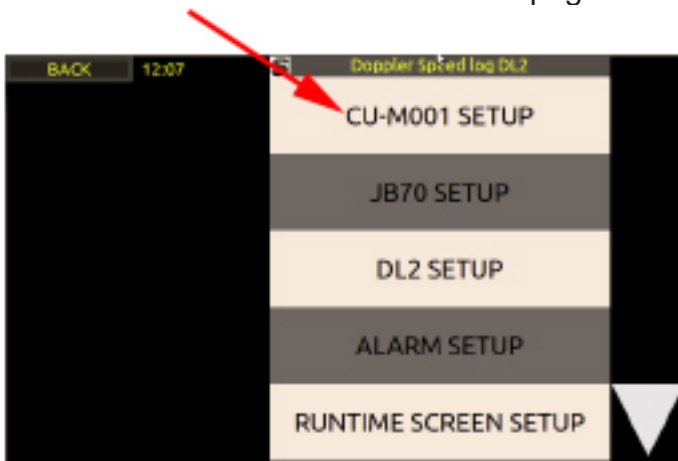

To enter and adjust these screens a password is required. The password for all units is ‘service’. The password will be remembered for 1 hour, or until reboot of the system.

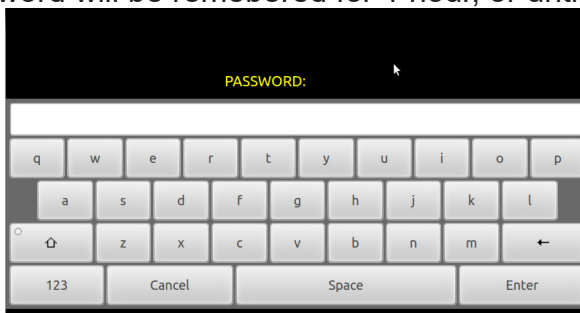

CU-M001 SETUP

On starting the display CU-M001 first time it will try pair up with a JB70D2-SA.

Default settings:

Screen: Horizontal (no vertical available)

System type: DL2/DL21

IP Address: 172.16.1.102

SFI (System Function ID): II0102

Paired SFI: VD101(default SFI of JB70D2-SA)

Group:NAVD.

Dimming: Rx

NOTE:

If connected to LAN network please make sure IP addresses, SFIs and Group is approved by local administrator.

If 2 x DL2/DL21 systems are to be installed on same LAN then IP address SFI and paired SFI have to be changed on (at least) one of the systems to avoid conflict of settings.

If default values have to be replaced then please change IP address of JB70D2 before changing on CU-M001.

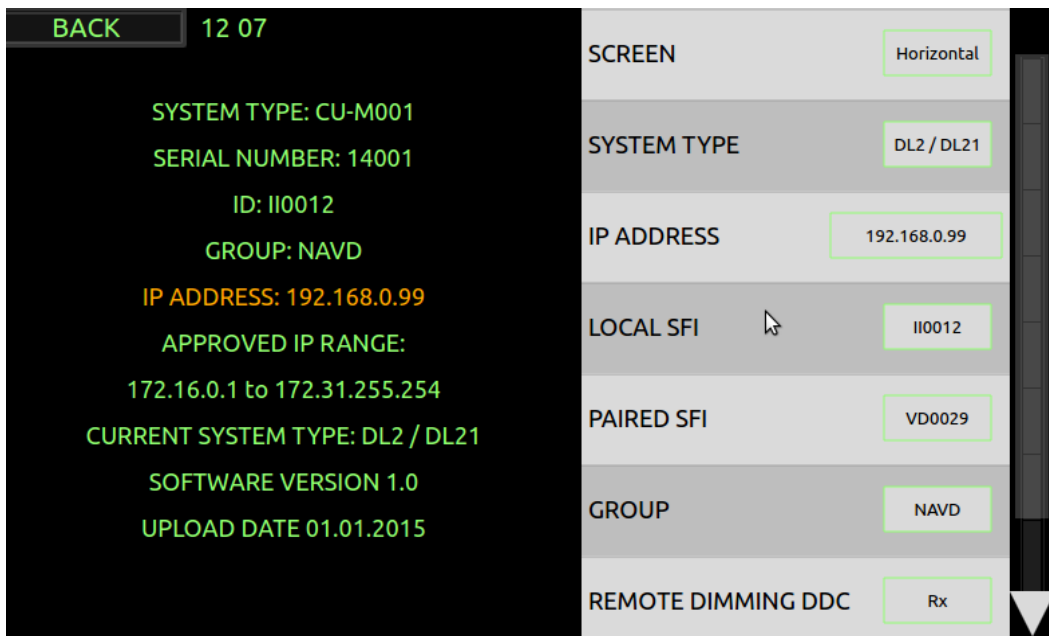

Remote dimming DDC

Off

The screen can be dimmed on screen.

Rx

The screen can be dimmed on screen or using a remote DDC message. The system can be made to accept remote dimming from the local input or the JB70 input.

Tx

The screen can be dimmed on screen or using a remote DDC message. The system can be made to accept remote dimming from the local input or the JB70 input.

It can also be made to send a DDC message when the dimming level is changed.

JB70D2 SETUP

BACK	12 07	IP ADDRESS	192.168.0.97
SYSTEM TYPE: JB-70		LOCAL SFI	VD0029
SERIAL NUMBER: 99999		GROUP	NAVD
ID: VD0029		Alarm SFI	AS1234
GROUP: NAVD			
IP ADDRESS: 192.168.0.97			
APPROVED IP RANGE:			
172.16.0.1 to 172.31.255.254			
ALARM SFI: AS1234			
SOFTWARE VERSION 1.0			
UPLOAD DATE 01.01.2015			

Default settings:

IP Address: 172.16.1.101
SFI (System Function ID): VD0101
Group:NAVD.
Alarm SFI: AS0101

When on this setup page, the user is setting parameters on the remote device. It is therefore important that the devices are properly connected before adjusting here. If the devices are not connected you will see a system alarm on screen. Pressing this symbol will show which alarm is active.

This process can also be performed in a simpler way by using the Communications Application available in the SKIPPER service software (available for download on the SKIPPER website.) This App allows you to connect to the same network as the units and then perform a search. The software will show you all the connected units, and you may then edit the IP address, SFI and group from the software. You may then enter the web pages for each individual unit.

DL2 SETUP

To help the system to calculate accurate a number of parameters should be setup for the specific vessel it is installed into. These are entered in the DL2 setup menu.

DL2 setup is accessible from the “config” menu.

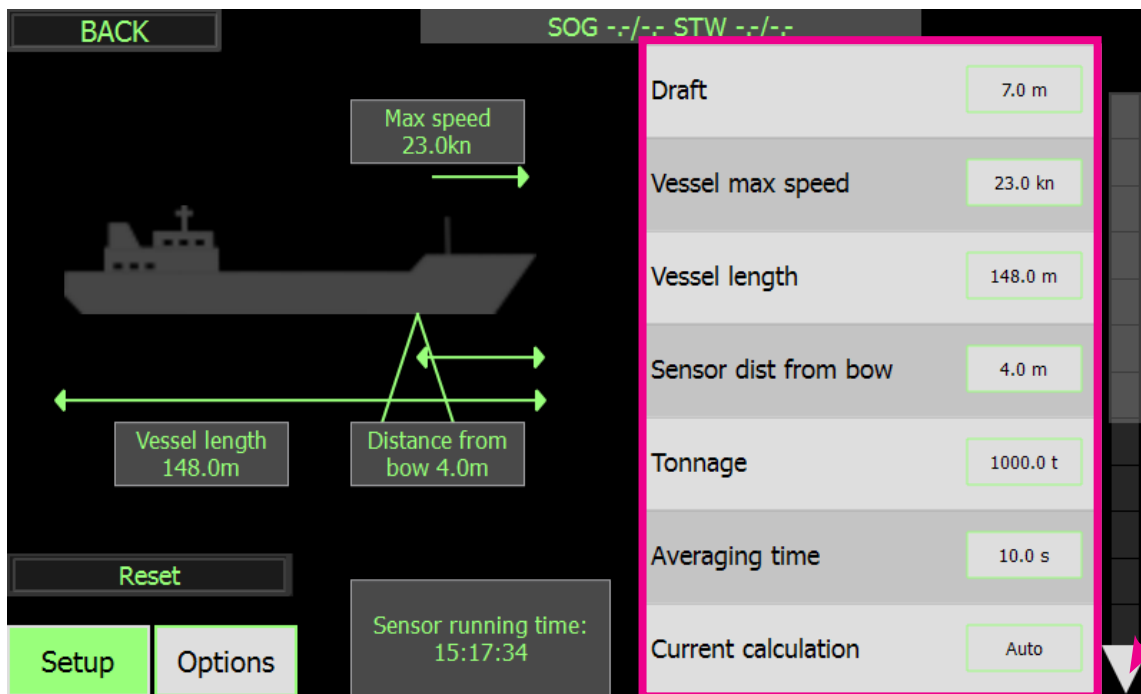
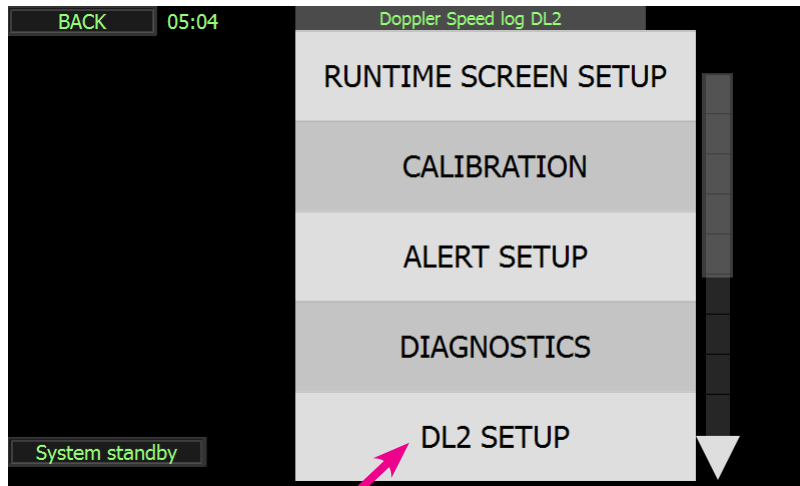

Press “arrow” to access more buttons

Button	(default) options	What it is used for
Draft	(meters) feet fathoms	Used to make the depth value show from the surface and not from the sensor.
Vessel Max Speed	(knot) m/s mi/h	Used to set the calibration parameters and to ensure data is reasonable.
Vessel Length	meters	Used to calculate The Aft transversal speed (ROT signal must be input for this)
Sensor distance from Bow	meters	Used to calculate The Aft transversal speed (ROT signal must be input for this)
Tonnage	tonnes	Used to set correct averaging time. Larger vessels will have slower speed changes and may use a higher averaging to calculate the speed.
SOG Averaging time	seconds	Manuel set of averaging time for SOG at speeds over 6kn. This setting will override settings from "Tonnage"
SOG low speed averaging time	seconds	Manuel set of averaging time for SOG at speeds under 6kn. This setting will override settings from "Tonnage"
STW averaging time	seconds	Manuel set of averaging time for STW at speeds over 6kn. This setting will override settings from "Tonnage"
STW low speed averaging time	seconds	Manuel set of averaging time for STW at speeds under 6kn. This setting will override settings from "Tonnage"
Current calculation	(AUTO) Log-SOG, GPS-SOG AUTO	The "Water current" speed and direction are calculated from the STW measurement and an SOG from the log and/or a GPS input. In deep water,(depths>150m) SOG is not available from the log. AUTO will automatically change from log to GPS when log bottom is lost. Log-SOG will allways calculate "Water current" with SOG from log. GPS-SOG
GPS on lost bottom	(ON)/OFF	If the water is too deep, the system cannot measure SOG. This option will switch the value to GPS (on screen) with a small symbol to indicate where the data comes from. The system will not send SOG data on its outputs in this case.
Vessel image	1-5	The image of a vessel can be changed to various vessel types.
SOG Shallow ping length	1-(2)-4-8msec.	Default 2msec. May be set to 1msec for better shallow water
SOG Deep ping length	1-2-4-(8)msec.	Default 8ms for deeper bottom tracking
SOG Shallow power	Low-Medium-(High)	Default High. Power level of SOG signal in shallow water
DL1/DL2 synch	OFF / (ON)	In DL2 the systems can be made to ping simulataniously to prevent acoustic cross over
Sampling Distance	(0.5)-16m	The STW water sample can be moved further from the vessel to reduce effects of drag.
Low speed correction	(ON) off	activation of a filter to improve alongside data.

Output parameters	SOG+STW SOG only	<p>If the system is configured as a DL21, it should be configured such that the STW parameter to radars etc comes from the DL1 part, and the SOG comes from the DL2 part. To ensure this the button SOG only / SOG+STW is set, and then disables the STW parts of the DL2. Instead the DL1 STW (single axis) still be displayed on the screens.</p> <p>The outputs will change so that STW is not available in the VBW NMEA sentence on the DL2, but is available on the VBW from the DL1</p> <p>If a single set of repeaters is to be used. The SKIPPER Multi repeater CD401MR-SB can be used ,and set up so that it shows SOG from the \$VDVBW sentence , and STW from the DL1, which is retransmitted through the DL2 in the \$VDVHW sentence or all together in the special \$PSKPVBWX sentence. To do this configure Screen 1 on the repeater to SOGL and SOGT, and Screen 2 to STW-R. In the DL2 activate either VBW and VHW or VBWX.</p>
Primary STW Frequency	(High freq), Low freq	<p>The STW parameter can measure at both high (850-910kHz) and low (265-278kHz) frequency. High is normally better, but the user can change to low frequency. Both frequencies are calibrated during a Sea test calibration, and the Current primary is displayed in the Calibration settings as default.</p>
SOG Freq. Change point	(0) 0-10m	<p>The SOG parameter is also improved in shallow water by using the high frequency. This value is the depth at which the SOG starts using the high frequency</p>

Important settings at time of installation:

Vessel max speed. Please insert before first time speed calibration. Calibration may be lost if Max speed is changed.

Vessel length and Sensor distance from bow. Required for Aft transversal speed calculation.

Tonnage and averaging time: Response time of speed log should be set correct to the specific vessel. Normally response is relative to tonnage of vessel. A default averaging time is set on basis of tonnage input but the averaging time may be manually adjusted independant of tonnage.

Saving settings on USB Stick:

Once settings have been setup it is possible to save the settings by inserting a USB Stick. This will create (or Use) a folder called /skipper/downloaded_setups and in this folder it will create a directory with the DL2 system serial number

reloading settings from a USB Stick:

To reload a setting the directory with the serial number must be copied into a directory under /skipper/upload_new_setup/

This will be copied into any system the USB stick is placed. Wait until the system has rebooted before removing

RESET

There are 4 available reset options.

1. Reboot of software
2. Reset settings: Will reset settings for NMEA, AUX and DL2 setup back to default.
3. Reset settings and calibration: Will also set calibration settings to default.
4. Reset all: Will set the system calibration and communication settings (IP) back to default

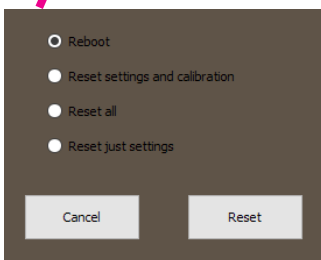
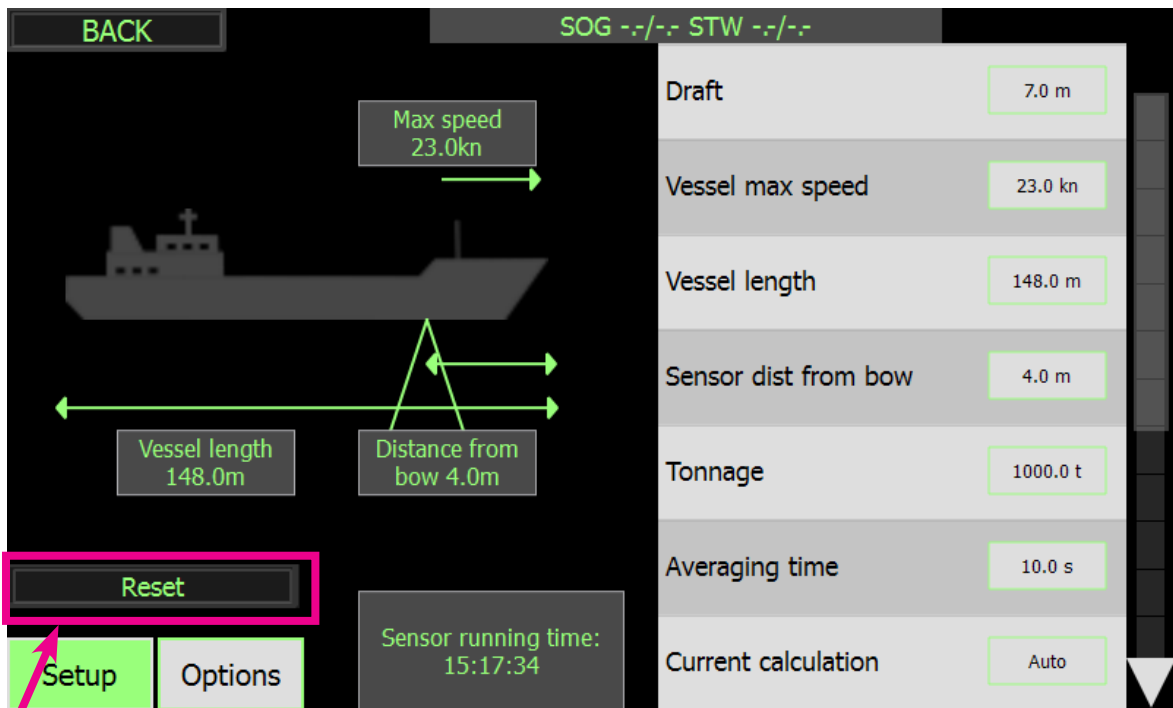

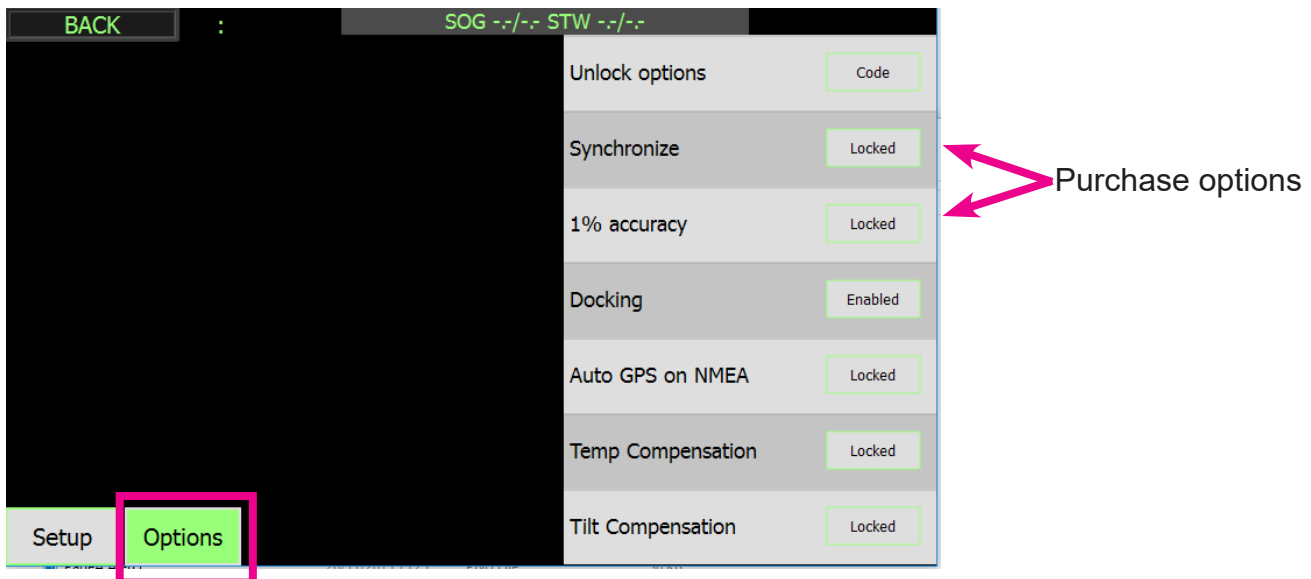

SOFTWARE OPTIONS

The DL2 system has a number of options available. The software and hardware in this product is designed to meet the requirements of MED and IEC 60945. The product in its standard form is limited to meet the specification required. However, it is designed to allow adjustments and improvements to be implemented so that the product can be used in markets requiring higher specification and functions not standard in a commercial speed log.

There are currently 2 available purchase options. These are activated by entering the code provided by SKIPPER in the correct field. All options can be activated in retrospect (at an additional cost) by giving the system serial number to SKIPPER, they will send the activation code in return

Purchase options

- **1% accuracy**

DL2 is default 2% accuracy. Activating 1% accuracy option will give the option in the DL2 menu, and in each NMEA output menu, to configure to show 1 or 2 decimals, on the screen values and NMEA sentences.

Will enable a set of filters and features that will ensure and check, that the unit is operating within 1% specification.

- **Synchronize**

This option enables the user to send a mute signal to stop the sensor from pinging.

There are 2 synchronize input options:

- AUX level into the aux input to stop the sensor.
- NMEA message input \$PSKPBLNK,2,1,ON*nn or \$PSKPBLNK,2,1,OFF*nn where ON is mute

There are 2 synchronize output options:

- AUX “SyncOut” will give a pulse out when sensor is confirmed muted from external input.
- AUX “PingOut” will give a pulse out when sensor is pinging.

Please note!

The sensor pinging is a very short repeating pulse of 1-8 milliseconds.

Due to electronics delay the sensor will mute 8ms after a level change on the Aux input.

When Synchronize is active a warning M will be shown on the screen, after 10 seconds of mute, the system will detect this as a sensor failure and give a system alert.

Non-Pay options

Docking

Auto GPS on NMEA

Temp compensation

Tilt compensation

Activating/de-activating software options.

Software options can be activated and de-activated in the DL2 menu. This page contains a table where the installer can enter codes purchased/supplied from SKIPPER. Codes will only activate if they detect the correct hardware in place. Codes are unique to the serial number of the system and can not be moved from system to system. To remove an extra option, the user must re-enter the code number.

COMMUNICATIONS SETUP (NMEA/UDP)

NMEA

The most common communication method to this type of system is the IEC61162-1 NMEA ports, these use an isolated input RS422 differential method. The IEC61162-1 standard requires 4800 baud, 8 databits, 1 stop bit and no handshake. The system also supports faster communications as specified in the IEC61162-2 standard using 38400 baudrate. If this standard is to be used the output requires a common connection available on J2 pin 11 or pin 12.

It is also possible to run the system at 115200 baud, although there is no standard to support this.

LAN UDP

In addition, this unit supports the LAN UDP standard (IEC61162-450)

Communication setup page is accessed via config menu.

Scroll down with the right sid arrow until "Communication setup" button is displayed.

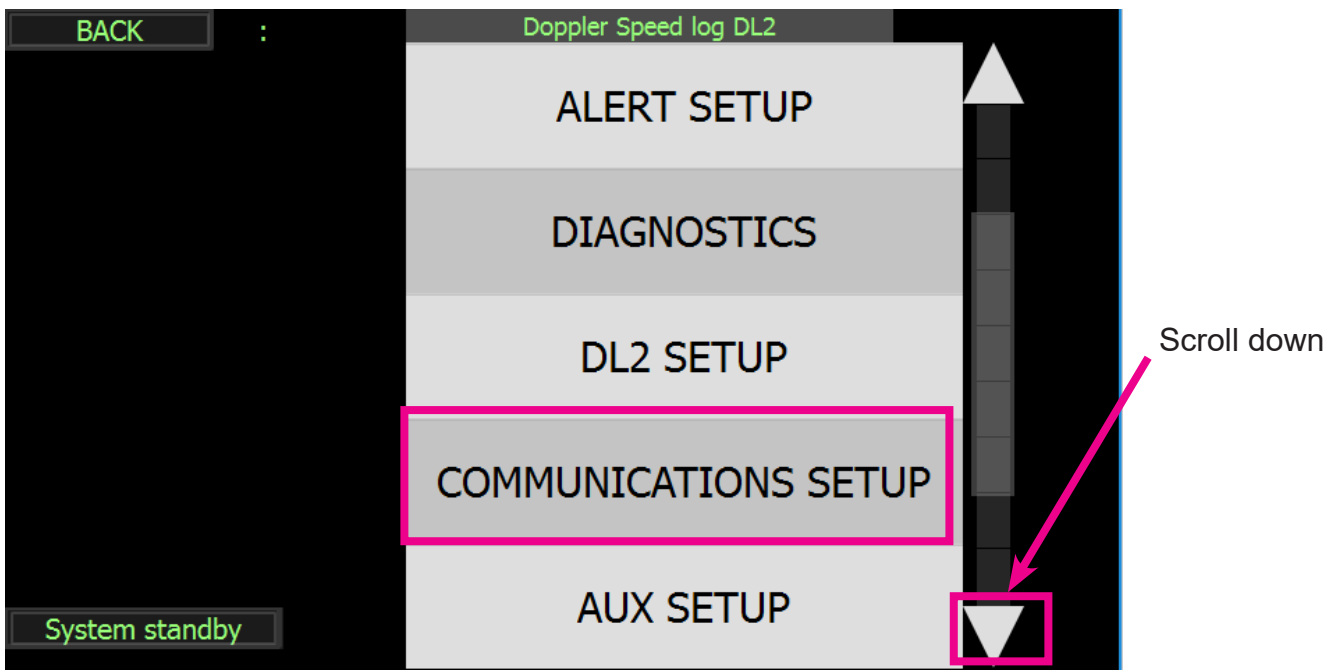

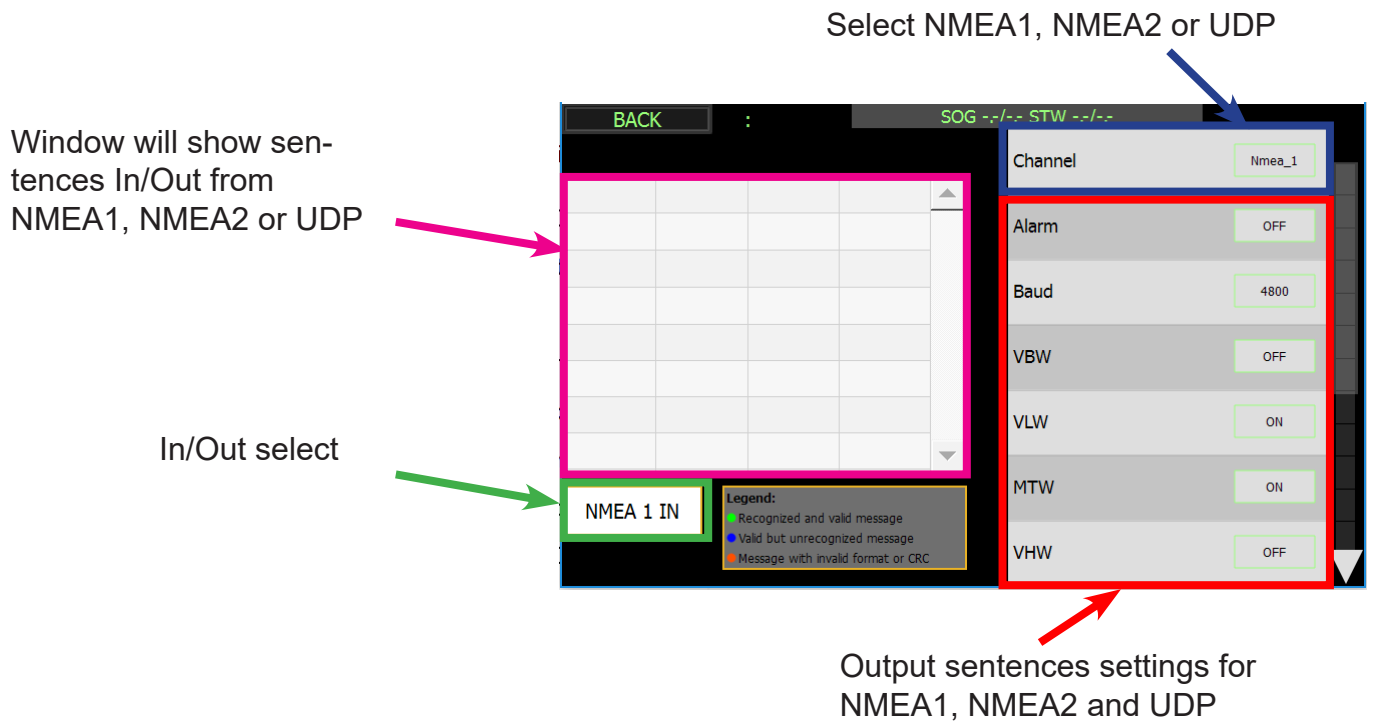

For each of the outputs 1, 2 and LAN (UDPM) it is possible to activate a number of sentences. Normally with On and Off. The resulting outputs are shown on the left on the screen. The alarm output has 3 choices ALR, ALF and OFF. This because only one of these should be selected at a time.

Output settings are password protected for changes. The password for all units is 'service'. The password will be remebered for 1 hour, or until reboot of the system.

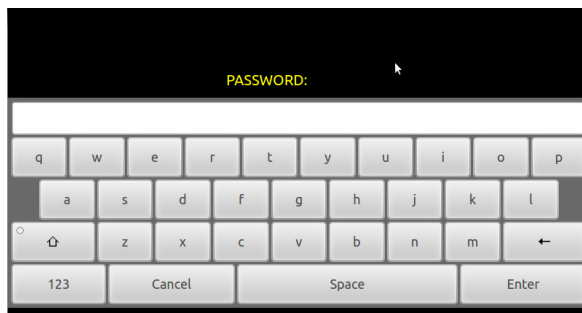

NMEA SENTENCES RECEIVED

If input is shown, then the system will colour code the headers to show if the data is recognised, and correct, recognised and not correct, or not recognised/used

All channels will detect inputs and automatically use those that are recognised

Time

Day, month, year	ZDA,hhmmss.ss,xx,xx,xxxx,xx,xx*hh<CR><LF>
------------------	-------------------------------------------

Position

Geographical lat/lon	GLL,llll.ll,a,yyyy.yy,a,hhmmss.ss,A,a*hh<CR><LF>
GPS position	GGA,hhmmss.ss,llll.ll,yyyy.yy,a,x,xx,x.x,x.x,M,x.x,xxxx*hh <CR><LF>

Rate of Turn

Rate of turn	ROT,x.x,A*hh<CR><LF> (Required for docking.)
--------------	----------------------------------------------

Alarm

Acknowledge alarm	ACK,xxx*hh<CR><LF>
	ACN,hhmmss.ss,aaa,x.x,x.x,c,a*hh<CR><LF>

Heading

Heading, true, present	HDT,xx.x,T*hh<CR><LF>
True heading and status	THS,x.x,a*hh<CR><LF>

Composite

Loran C specific	RMA,a,xxxx.xx,N,xxxxx.xx,W,,,xx.x,xxx.,,*xx<CR><LF>
GPS, transit specific	RMC,hhmmss.ss,A,llll.ll,a,yyyy.yy,a,x.x,x.x,xxxxx,,,*hh <CR><LF>

External trip reset over NMEA

Trip reset In SOG only mode Trip reset to DL2 will be transferred to DL1.	\$PSKPRSTT* <hh><CR><LF>
Trip and total adjust	\$PSKPSTL,<trip>,<Total>* <hh><CR><LF>

External dimming over NMEA

External dimming of display unit	\$--DDC, a, xx,a*hh<CR><LF>
----------------------------------	-----------------------------

Placing a system in standby

Set a system in standby or wake up	\$PSKPSTLP,<target SFI>,<sleep value>*hh command added for setting system to sleep or waking up. <target SFI> can be JB's SFI or SFI of a display paired with JB of a particular system, <sleep value> is "1" or "0", "1" - sleep
------------------------------------	-----------------------------------------------------------------------------------------------------------------------------------------------------------------------------------------------------------------------------------------

A number of proprietary inputs may also be present (particularly on the LAN channel) to communicate with the display and JB70 unit

NMEA SENTENCES TRANSMITTED

(talker) (IEC 61162-1:2007(E) (NMEA 0183) messages:

Speed and distance

Name	Description	Example
VTG	Course over ground and ground speed	\$VDVTG,,,,,x.x,N,x.x,K,a*hh<CR><LF>
VHW	Water speed and heading In SOG only mode VHW will show water trip and total from DL1	\$VDVHW,,,,,x.x,N,x.x,K*hh <CR><LF>
VLW	Dual ground/water distance In SOG only mode VLW will show water trip x.x and total y.y from DL1, and Ground total a.a and Ground trip b.b from the DL2	\$VDVLW,x.x,N,y.y,N,a.a,N,b.b,N*hh<CR><LF>
VBW	Dual ground/water speed in SOG Only mode VBW first field will show data from DL1 STW	\$VDVBW,x.x,x.x,A,x.x,x.x,A,x.x,A,x.x,A*hh <CR><LF>
VBWX	Dual ground DL2/water DL1 speed As VGW with DL1 speed and validity in the last 2 fields	\$PSKPVBWX,x.x,x.x,A,x.x,x.x,A,x.x,A,x.x,A*hh <CR><LF>

Temperature

Name	Description	Example
MTW	Water temperature	\$VDMTW,x.x,C*hh<CR><LF>

Alarm

Name	Description	Example
ALR	Set alarm state	\$VDALR,hhmmss.ss,xxx,A,A,<Alarm message> *hh<CR><LF>
ALF		\$VDALF,x,x,x,hhmmss.ss,a,a,aaa,x.x,x,x,x,x,c---c*hh<CR><LF>
ALC	Cyclic alert list	\$VDALC,xx,xx,x.x,aaa,x.x,x,x,x,x,....,aaa,x.x,x,x,x.x*hh<CR><LF>
ARC	Alert command refused (Not in use by DL2)	\$VDARC,hh,mm,ss.ss,aaa,x.x,x,x,c*hh<CR><LF>
HBT	Heartbeat	\$VDHBT,xx,A*hh<CR><LF>

Depth

Name	Description	Example
DPT	Depth	\$IIDPT,x.x,x.x*hh<CR><LF>

Values will be preceded with sign as needed (e.g “-“ = Astern, Port).

*hh = Checksum.

ALARM/ALERT SETUP

According to INS standard IEC61924-2 Annex C speed logs may be able to handle “Speed Low Alarm” as a Category B alarm. Acknowledge can be remote.

The DL2 has 4 I/O options for alarm communication:

- NMEA ALR/ALF message
- LAN ALR/ALF message
- AUX optocoupler
- Alarm relay

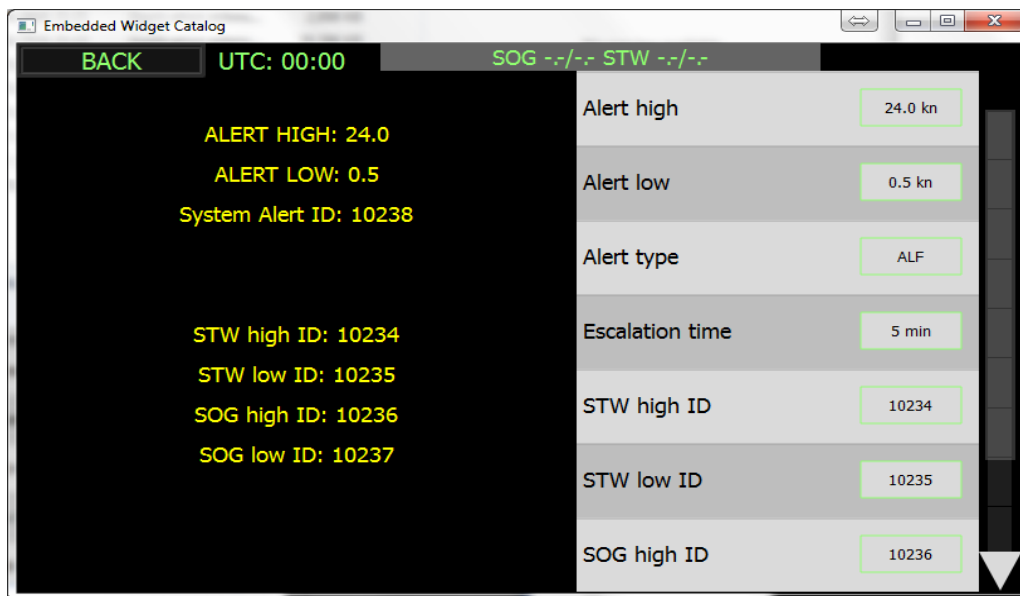

Remote acknowledge can be set up by aux input, by ACK or ACN (both from NMEA port and LAN). Alarms are available for low speed (SOG and STW), high speed(SOG and STW) and system failure. They can be activated or deactivated and given a unique alarm ID. Each alarm has its own unique ID and message, and can be deactivated by making the ID zero.

The messages in use are as follows:

Alarm type	Alert identifier (adjustable*)	Alert Text	Mnemonic code
SOG SPEED HI	10234	‘SOG Speed Hi’	SKP
SOG SPEED LO	10236	‘SOG Speed Lo’	SKP
STW SPEED HI	10235	‘STW Speed Hi’	SKP
STW SPEED LO	10237	‘STW Speed Lo’	SKP
SYSTEM warning	10238	‘SYSTEM ALARM’	SKP

* Note some systems may only accept 3 digits in ALR messages. In this case remove the 10XXX

transmit) ALR messaging

	\$VDALR,hhmmss.ss,xxx,A,A,<Alarm message> *hh<CR><LF>
\$VDALR	ALR message from VD (=Velocity Doppler)
hhmmss.ss	Time of alarm condition change, UTC
xxx	Unique alarm number (Id) at alarm source.
A	Alarm condition. A=Treshold exceeded, V=Not exceeded.
A	Alarm acknowledge state. A=Acknowledged, V=Unacknowledged.
<Alarm message>	Alarm description text: “Low speed” or “High speed”
hh	Checksum
<CR><LF>	Carriage return and line feed (Normally not visible)

Initially at “no alarm” no messages will be sent , occasionally \$VDALR,,V,V,*nn.

If one of the “Low speed” or “High speed” alarms are exceeding treshold, the alarm exceeding threshold will send an alarm message. In below example WT and BT has exceeded “High speed” treshold. The unique alarm number (Id) is as shown in the alarm type table above, A is “Alarm condition” “Exceeded”. V is “Unacknowledged” state.

\$VDALR,152609.17,10235,A,V,STW Speed Hi*nn
\$VDALR,152609.17,10234,A,V,SOG Speed Hi*nn

If the touch display is touched or ACK acknowledge command is sent to DL2.

A is “Alarm condition” “Exceeded”.

A is “Acknowledged” state.

\$VDALR,152619.17,10235,A,A,STW Speed Hi*3B
\$VDALR,152619.17,10234,A,A,SOG Speed Hi*2C

When speed is again inside treshold ALR message will change to “No alarm”, “Acknowledged” on all.

V is “Alarm condition” “Not exceeded”.

A is “Acknowledged” state.

\$VDALR,152725.75,10235,V,A,STW Speed Hi*26
\$VDALR,152725.75,10234,V,A,SOG Speed Hi*31

If the user acknowledges, the sentence will show 1 time the acknowledged state

\$VDALR,152725.75,10235,V,V,STW Speed Hi*26
\$VDALR,152725.75,10234,V,V,SOG Speed Hi*31

and then return to its normal state of sending

\$VDALR,,V,V,*26

at least 1 time per minute (HBT sentence is also sent every minute)

(receive)ACK Acknowledgement (works if ALR is activated)

\$ _ACK	ACK acknowledge header
	Time of alert command UTC (if available)
x..x	Alert identifier
hh	Checksum
< CR><LF>	Carriage return and line feed

transmit) ALF messaging

The DL2 alarms are classed as category B, and can use the full protocol of INS alarming.

At time of print ALF is the most modern and recommended standard for alarming. (IEC61924-2 and its corregendum 1) This alarm method should not be used at the same time as ALR.

ALF message works in conjunction with ACN, HBT, and ALC is defined

\$VDALF	ALF message from VD (=Velocity Doppler)
x	Total number of ALF sentences (1)
x	Sentence number (1)
x	Sequential message identifier (1)
hhmmss.ss	Time of alarm condition change, UTC (if available)
a	Alert category (B)
a	Alert priority, E A W or C (A)
a	Alert state A,S,N,O,U or V V= Active unacknowledged (Like ALR A,V) S= Silenced A=Active acknowledged (Like ALR A,A) O = Responsibility transfered U = Rectified unacknowledged (Like ALR V,V,...) N = Normal (like ALR V,V with no ID)
aaa	Manufacturer mnemonic code (SKP)
x..x	alart identifier
x..x	alert instance 1-999999"
xx	Revision counter 1-99
x	Escalation counter 1-9
c--c	Alert text (see list of alarm types)
hh	Checksum
<CR><LF>	Carriage return and line feed (Normally not visible)

example

\$VDALF,1,1,0,124304.50,B,W,V,10234,SKP,1,1,SOG Speed Hi*hh

(received) ACN Acknowledgement (works if ALF is activated)

\$ ACN	ACN acknowledge header
	Time of aalert command UTC (if available)
aaa	Manuafacturer Mnemonic (as in alarm types table)
x..x	Alert identifier
x..x	Alert instance
c	Alert command A,Q,O,S A= Acknowledge Q= Request to repeat ALF O= responsibility transfer S= silence
a	Sentence status flag
hh	Checksum
< CR><LF>	Carriage return and line feed

Example

\$HIACN,124305.50,10234,SKP,A,A*hh

(transmit) ALC Cyclic alert list (sent every 30 seconds when ALF is activated)

If the system receives this command, it will resend the active ALF sentences

\$ ALC	ALC header
xx	total number of sentences for this message
xx	sentence number
xx	sequential message identifier
x..x	number of alert entries
aaa	manufacturer mnemonic code
x.x	alert identifier
x.x	alert instance
x.x	revision counter
.....	additional alerts
aaa	manufacturer mnemonic code
x.x	alert identifier
x.xalert instance
x.xrevision counter
hh	Checksum
< CR><LF>	Carriage return and line feed

(transmit) HBT Heartbeat (sent every 60 seconds if ALR or ALF are selected)

\$VD HBT	Heartbeat header
xx	Configured repeat interval (60 sec)
A	Equipment status (A,V)
x	Sequential sentence identifier (0-9)
hh	checksum
< CR><LF>	Carriage return and line feed

Alarm using relay and AUX function

All ports marked AUX can be defined in the AUX setup. All AUX ports are isolated, most with optoisolators requiring a voltage to make them operate. 1 AUX output is a relay output and this can be used for normal alarm use or as a switch for a sounder (The system does not contain a sounder and this must be connected if the alarms are to be used without an external alarm system)

By default AUX input 1 is used for alarm reset, the relay is used for alarm output. A second AUX output can be used as a separate power failure alarm if required. If the relay is used for an alarm sounder, then AUX should be set to 'alarm beep output'. This will cause a beep 3 times every 7 seconds while an alarm is active and not silenced.

Testing Alarm functions

On the Diagnostic configuration screen, it is possible to press a test alarm button. This will cause an alarm using the settings in place. an 'S' will be shown on screen to indicate an alarm simulation is in progress.

IMPORTANT This system does not contain an acoustic sounder for alarm. If no central alarm system is installed, then a separate sounder must be installed. This sounder must beep at between 75 and 85dBA (as specified in IEC60945 §11.1.3)

SETUP AUX

The Auxiliary inputs and outputs can be assigned to different functions in the AUX Setup screen.

If Speed warning is selected on one of the output channels, then the user can set a high and low limit. At this speed the state of the output will change.

The current state of the AUX input and outputs are shown in the table below

Name	Type	Pin numbers (J2 Aux)
Aux 1 Output	Opto-isolator	7 +, 9 -
Aux 2 Output	Opto-isolator	2+, 4-
Aux 3 Relay	Relay	1 NC, 3 Com, 5, NO
Aux 1 Input	Opto-isolator	2+, 4-

Speed warning changes the output state as the vessels speed passes a set speed, this can have 2 values low and high. These values are set using below buttons.

NOTE. Do not use the Aux 3 Relay output for pulse speed output as the relay has a limited number of switching cycles.

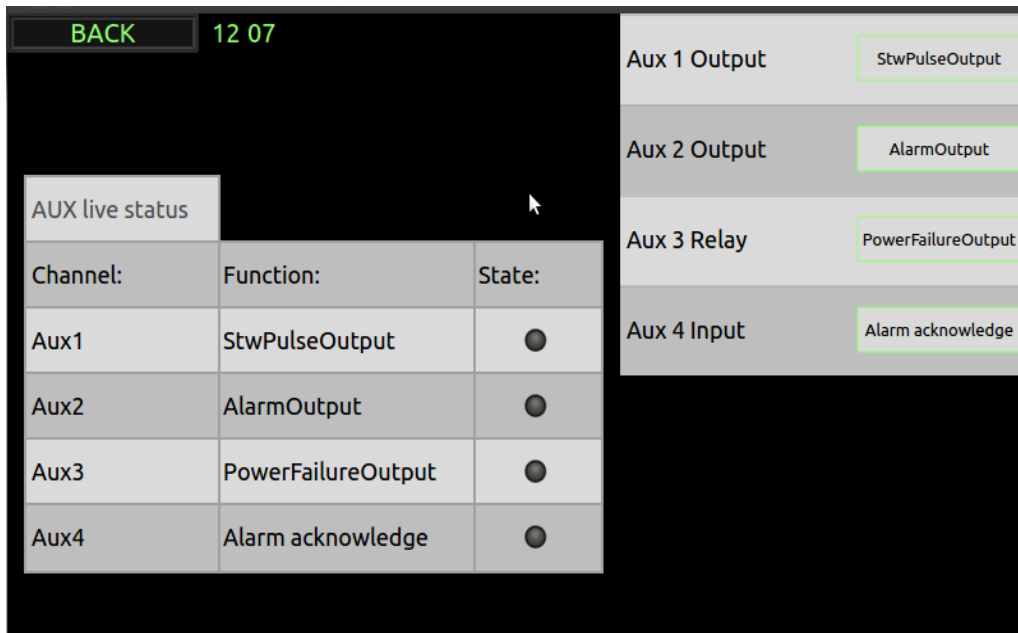

Options for the Auxilliary output are.

Option	Description	Option Code required?
STWPulseOutput	200 PPNM showing STW	No
SOGPulseOutput	200 PPNM showing STW	No
AlarmBeepOutput	The output will click 3 times every 7 seconds when an unacknowledged alarm is active	No
AlarmOutput	The state will change when an unacknowledged alarm is active	No
SpeedLimit	The State will change when it enters the speed zone	No
AlarmReset (input)	All active alarms will be acknowledged when the state of this is changed	No
Mute (input)	The sensor is silenced when this is active	Sync Option
Synch Out	When the sensor is confirmed silenced, this changes	Sync Option

SYSTEM DIAGNOSTICS

The Diagnostics screen allows the user to test the system, activating alarms and outputting set speeds. It is also possible to perform self test of the system and check the status.

Self test will perform the following actions:

- Check internal voltages and compare them to defaults and installation references.
- Check connectivity and connected items.
- Disconnect NMEA ports and loop back to check circuit function.
- Measure function of the sensor (pinging between channels and analyse returning signals).

To test other systems connected to this system, a data test is available, allowing output parameters to be entered and given out on all the activated outputs. In addition, an alarm condition can be simulated and acknowledged. For demonstration, a simulator can be activated to show a recorded data set over time. This function will turn off automatically after 6 hours or on power reset.

Speed simulation is a full check of the system. The speed information is set to the sensor and the sensor produces frequencies corresponding to the desired speed. In this way all parts of the system are in use, and this in itself is a good diagnostic check.

AVAILABLE OPTIONS IN THE DIAGNOSTIC PAGE

- Simulators
- Speed

In this page it is possible to set a fixed speed and send this to the sensor. This will result in the speed being presented on all displays and outputs. This mode is a full simulator and will verify that all electronics and processing in the system are operational. When active an orange 'S' will show on screen.

- Alarm

By pressing the alarm simulator a typical alarm will become active. this can be acknowledged as normal, and will disappear when the simulator is removed.

ERROR MESSAGES

The following error cases are accounted for.

Error description	How you see it	Possible fault
Data from sensor missing.	On the screen the data disappears and is replaced by '-.-' The JB70 unit will send a system alarm. The status LEDS on JB unit shows constant orange	The sensor is not sending data. Check cabling between sensor and Electronic unit.
Data from sensor wrong	On the screen the data disappears and is replaced by '-.-' The Status LEDS on JB70 unit will flash orange	Sensor is not able to measure the speed.
Loss of communication between display unit and electronic unit.	On screen the following warning will occur 'Lost communication' The JB70 unit will send a system alarm.	The pairing between the Display unit and Electronic unit has failed. Check your cabling and check setup. (SKIPPER service software may be used)

1 The Display does not connect with the JB70 electronic unit

(Shows 'NO CONNECTION')

The display connects using a UDP LAN protocol. Both units must be set up to have an ID number and IP address. The skipper service software can be used to simply reassign all these values. Skipper service software available from the download pages of www.skipper.no.

2 No data from the sensor (the screen shows -,- instead of STW value)

This can be due to cabling issues to the sensor or sensor failure. Go to the config Diagnostics page, and run a self test. This will report no detected sensor, in this case. most likely problem is wrong cabling, but maybe the voltage is too low for the sensor. Measure the voltage at the junction near the sensor. This voltage should be >15V

If it is lower, remove the cable from the electronic unit and loop the end cable at this point, and measure the loop resistance. It should be according to the specification shown in chapter 2. The vaalues supplied for installation are worst case and the sensor will work normally with a loop resistance of up to 16 ohms.

If the voltage is ok at this point, check the NMEA output of the sensor (Blue/green) to check the sensor is operational. You can also measure current taken by the sensor, it should be in the region of 200mA at 24V (5W) and pulsing higher.

If this is not the case, try connecting a power supply with 24V directly to the sensor (Green +24V, Brown 0V) to see if unit starts.

If all this fails, there may be an error in the sensor.

SAVING AND LOCKING

The parameters will be automatically saved and if the the individual units of the system loose communications, they will re-synchronize when they reconnect.

HARDWARE OPTIONS

In addition to the mechanical options and software options, it is possible to select hardware options. These require an additional PCB and front plate. See appendix 3.

1. Extension card (available soon)

By adding an extension card (already in place in the DL21) it is possible to extend the system to have access to the IO of this card.

As DL21, this will give 2 extra NMEA, 2 analog outputs 1 extra Aux in and Aux out.

As DL2, this will give 6 extra NMEA outputs (total 10 with 3 channels), 2 Extra NMEA inputs (total 3), 2 analog outputs, 4 extra Aux outputs (Total 7) and 2 extra Aux inputs (total 3)

2. Dual system (DL21)

The DL2 (JB70D2 electronic unit) can also be upgraded with an extension card where the card can be used partly as extension (for analogue and extra NMEA outputs (2 extra)), and also as a separate single axis Doppler speed log. In addition to the PCB, an additional sensor or the sensor of type DL21S is required. This sensor contains both 2 axis (270 kHz) transducers, but also a single axis (715 kHz) speed log within the same housing. New regulations for vessels over 50 K GRT (Gross Register Tonnage) state that the vessel must have separate (electrically isolated) systems for speed over ground and speed through water. This system and the use of auxiliary +24 V DC power on the JB70D2-X electronic unit meets this criteria. A CD402CU-XX control unit will also be required for the secondary system.

CHAPTER 6: SOLVING PROBLEMS

The following section covers envisaged problems with the system.

SOFTWARE UPGRADE

The DL2 system consists of 3 software packages, All of these can be upgraded via the LAN interface. To do this download the SKIPPER service software from www.skipper.no. Install this on a PC and then connect to the unit, either through the ships network or directly. Then follow the instructions in the software.

As this product is new, there will be frequent improvements added to the software. Please monitor the SKIPPER web site to see if these are useful for you.

To upgrade select Come setup and search for systems. Check you can see the systems you are connected to. Set your PC's Network settings to Static ip address with address 172.16.1.95 Search with the software.

Close this window and go to the JB70D2 window. Search for the part to be ugraded. Press Download Firmware and follow the instructions

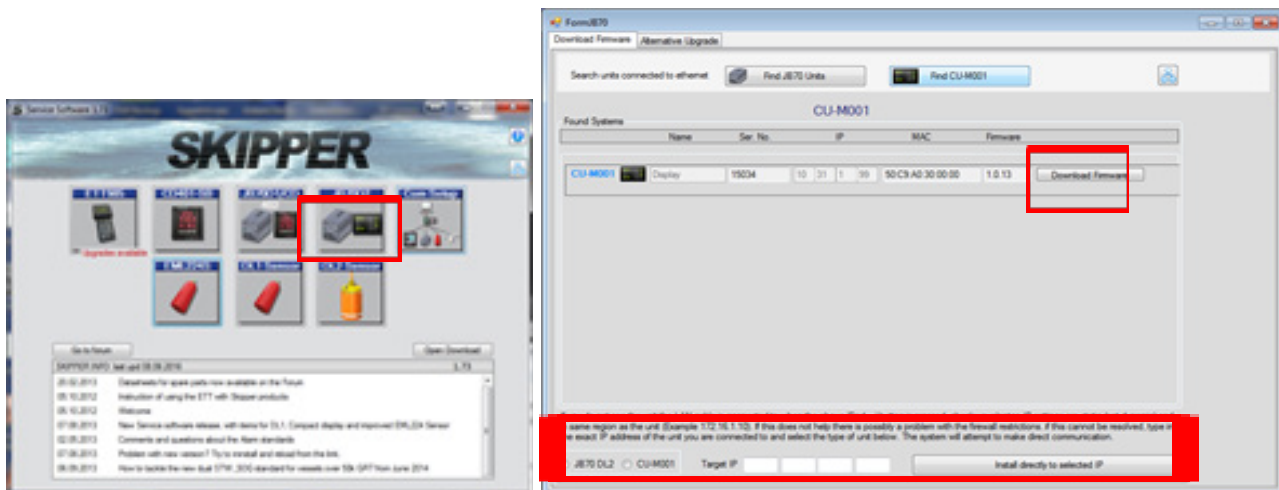

If you do not see the system you are connected to, type the IP address into the lower window. and select the system type (Default JB70D2 is 172.16.1.101, CU-M001 is 172.16.1.102)

Then select the software
 SW-M004 for JB70DL2 Electronic unit
 SW-M005 for CU-M001 Display

More updated information will be available on the SKIPPER forum (www.skipper.no/smf) and in the data bullitins

APPENDIX 1: INSTALLATION DRAWINGS

Operator unit Flushmount dimensions

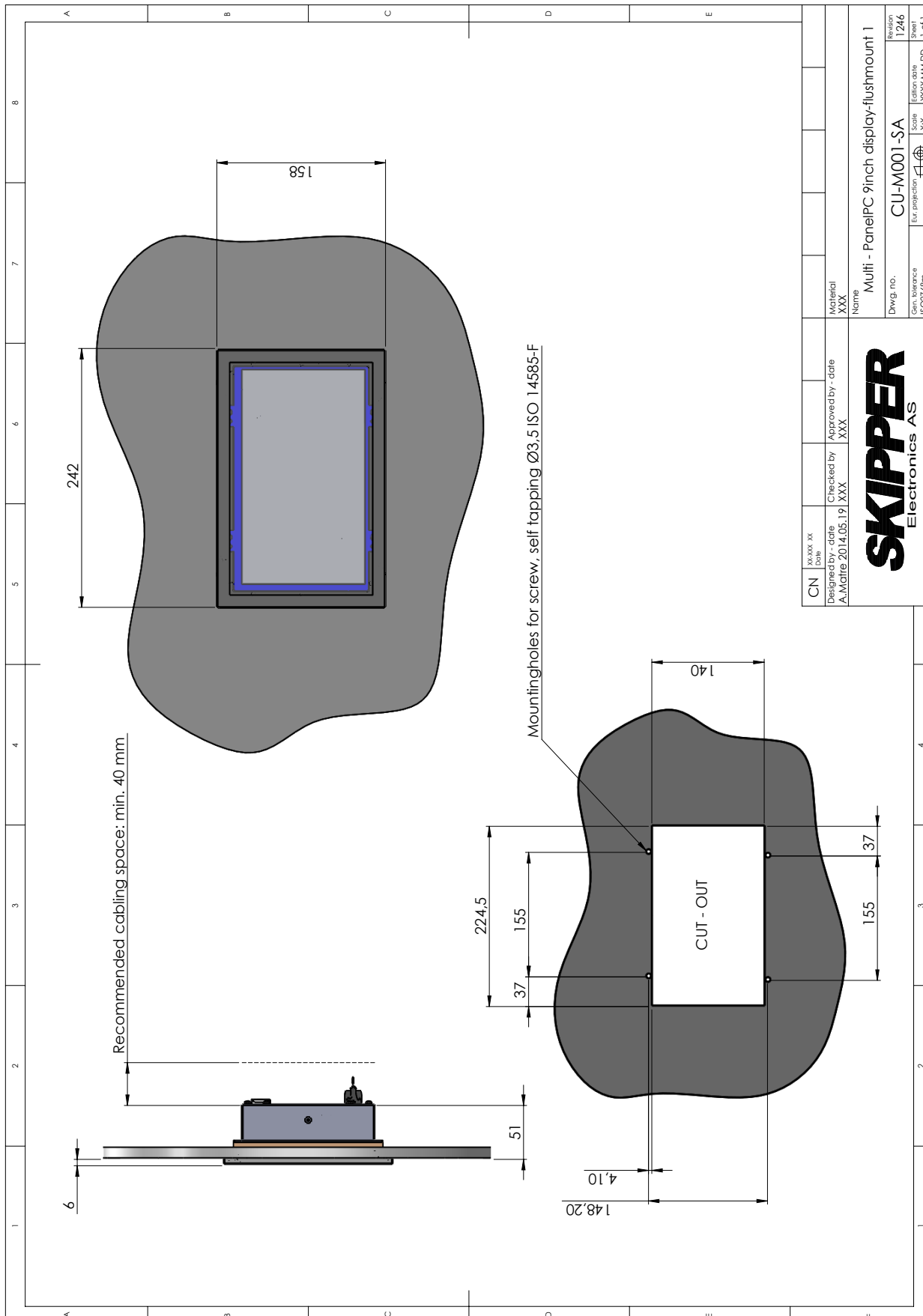

Optional operator unit desk/wall mount dimensions.
 (Requires part number: MG-0002. Mounting bracket for 9" touch display.)

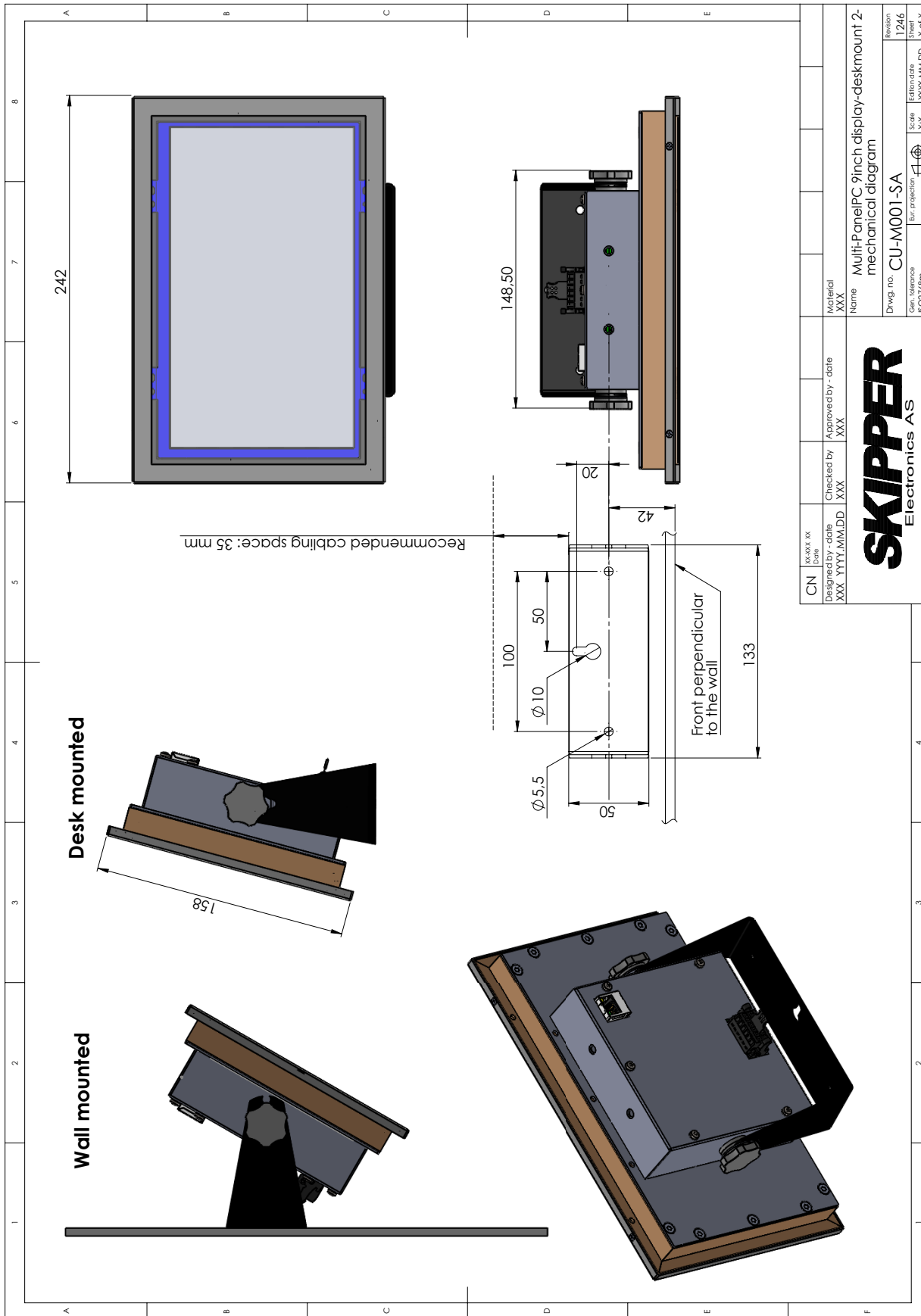

Electronic unit JB70 Dimensional drawings

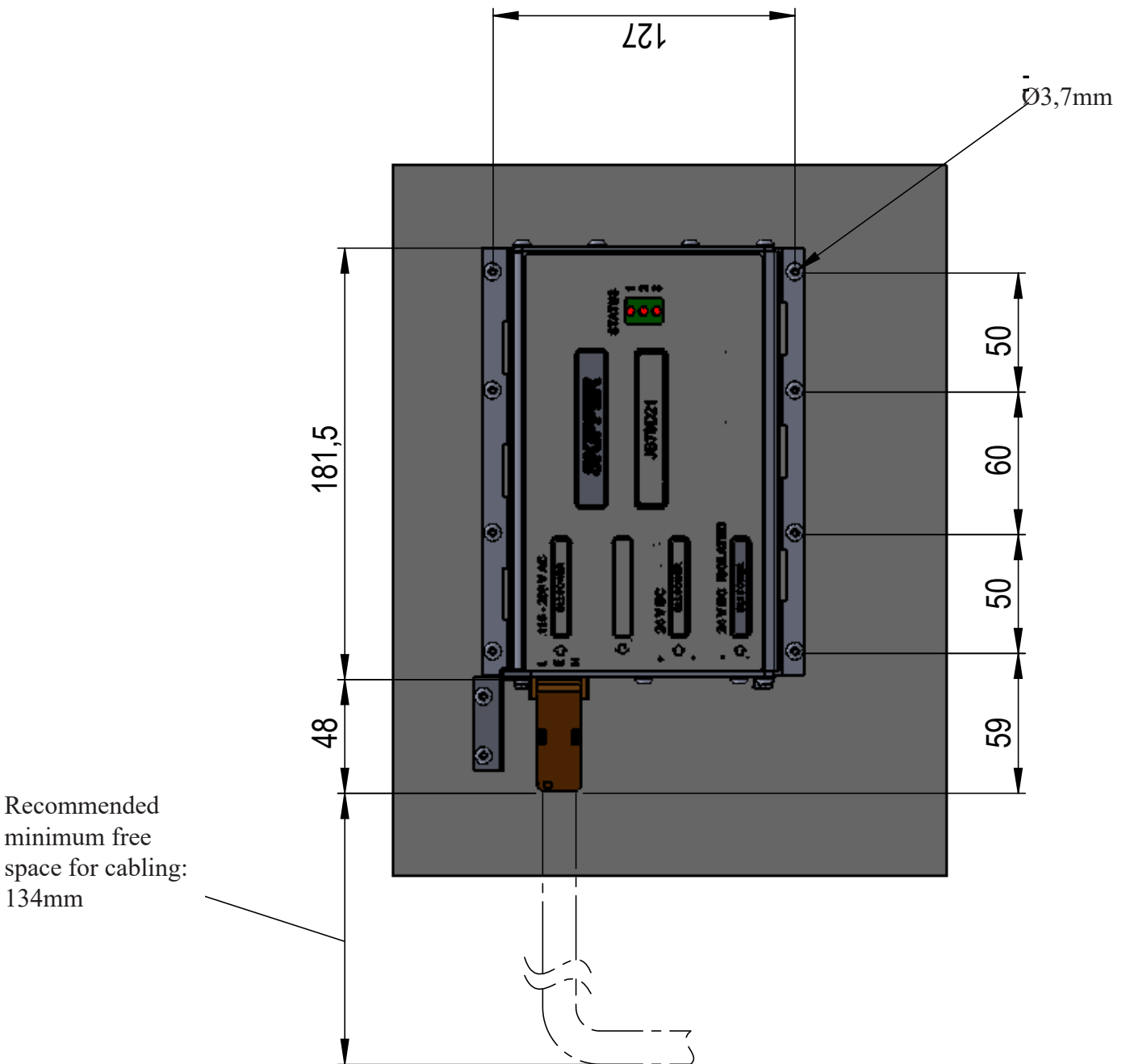

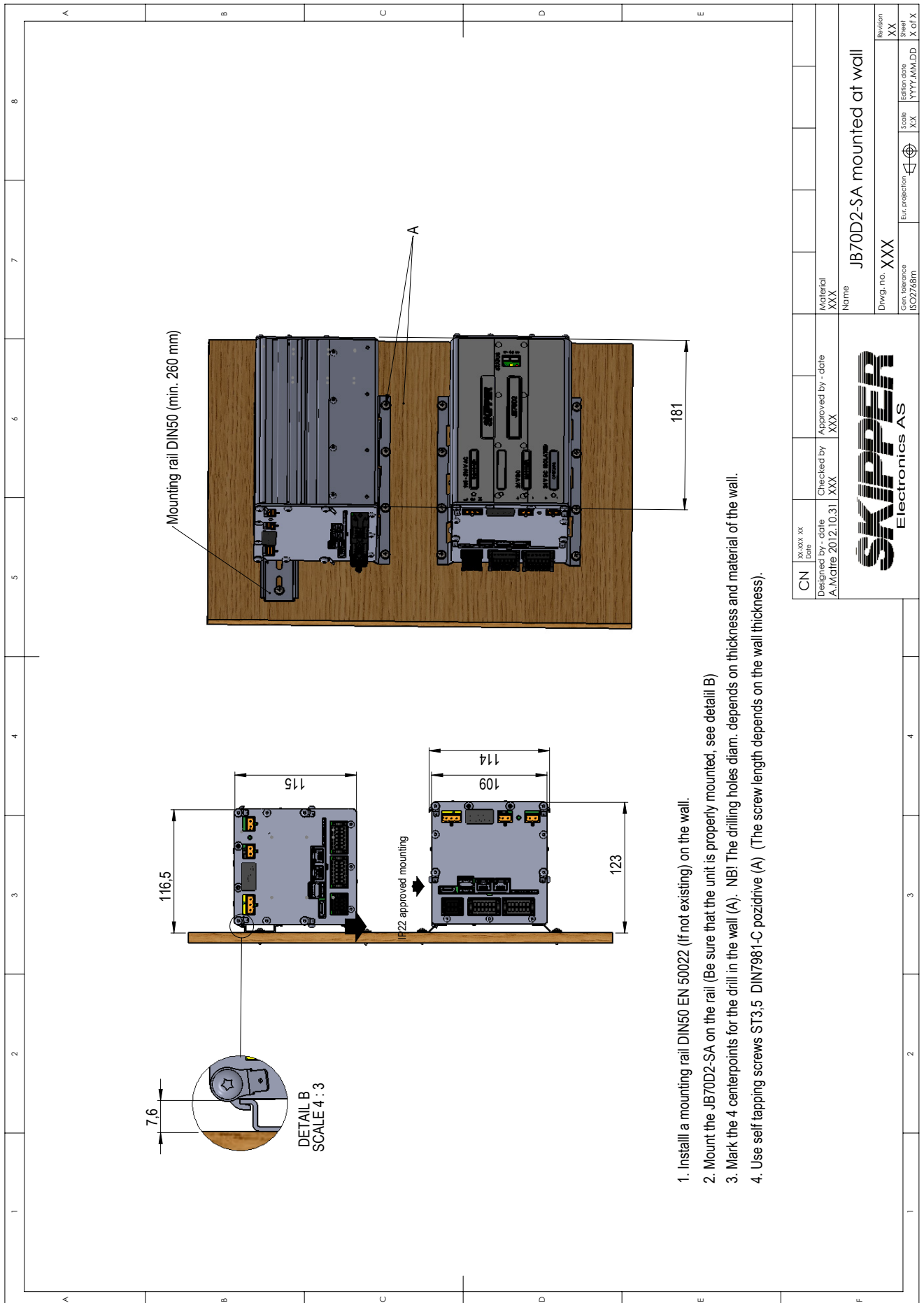

1. Install a mounting rail DIN50 EN 50022 (if not existing) on the wall.
2. Mount the JB70D2-SA on the rail (Be sure that the unit is properly mounted, see detail B)
3. Mark the 4 centerpoints for the drill in the wall (A). NB! The drilling holes diam. depends on thickness and material of the wall.
4. Use self tapping screws ST3.5 DIN7981-C pozidriv (A) (The screw length depends on the wall thickness).

CN	XX-XXX-XX Date	Checked by A.Mattre 2012.10.31	Approved by - date XXX	Material XXX					
Designed by - date A.Mattre 2012.10.31				Checked by XXX	Name JB70D2-SA mounted at wall				
				Dwg. no. XXX		Revision XX			
				Con. table no. ISO2768m		Eur. protection IP68		Scale XX	
				Erection date YYYY.MM.DD		Scale XX		X of X	



Junction box JB12 Dimensional drawings

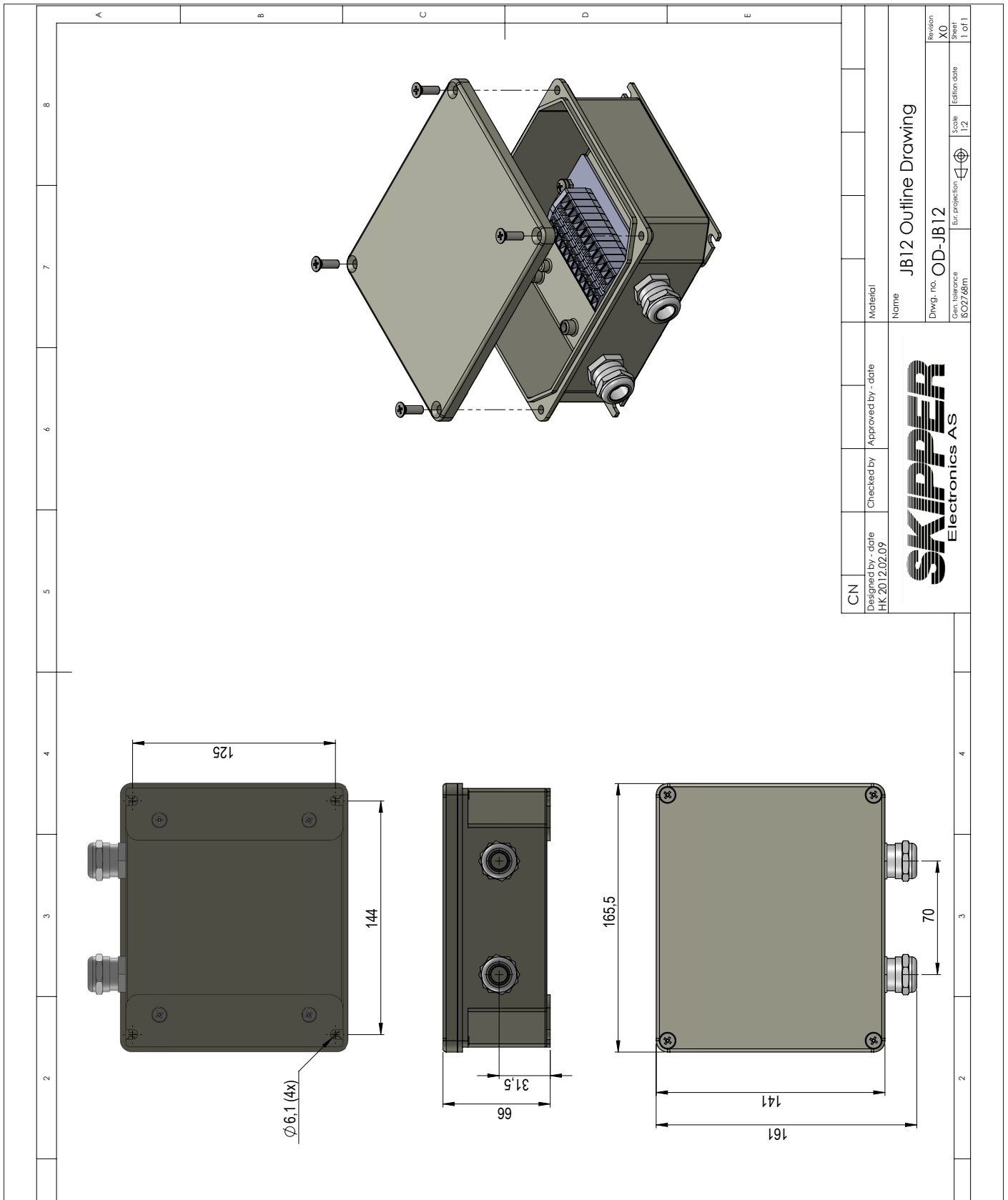

CN	Designed by - date HK 2012.02.09	Checked by	Approved by - date	Material
SKIPPER Electronics AS				
Name JB12 Outline Drawing				
Drawg. no. OD-JB12				
Cable reference SC02/68m				
Revision X0				
Scale 1:2				
Emission date 1 of 1				

APPENDIX 2: DATA SHEETS

Product Datasheet

CU-M001-SB / SD21-SB / SL1200-SB / ESN100-SB / ESN200-SB

Multi - PanelPC 9inch touch display

Specifications

Description	Multi - PanelPC 9inch touch display 9" Touch display. Resistive touch, Resolution 800 x 480. LED backlight. 400 Nits. Viewing angle 70/70/50/60 degrees Night dimming via touch or NMEA Flush mount, (wall mount or desktop mount option)
Input/Output	1 LAN. (IEC 61162-450) 2 NMEA in. 1 NMEA out. (NMEA 0183, IEC61162-1) 1 RS485/RS422 (NMEA use changes per product) Alarm Beeper
Used with	JB70XX-XX Electronic unit (CU-M001-SB(DL2,DL21), SD21-SA(SD21), ESN200-SB(ESN200)) JB40POW-SA Electronic unit (SL1200-SB(SL1200)) JB50E1-SA ESN100 Transceiver (ESN100-SB(ESN100))
Package consist of	9" Control unit Bracket for desk/wallmount Connector female, Power, NMEA, CAN
Mounting options	Flush, wall/desk with option MG-0002
Packaging dimensions	325 x 125 x 230 mm
Packaging weight	1,2 kg
Power consumption	12 - 24 V DC, max 10 W, typ 6 W
IP rating	22
Operating temperature	-15 to 55°C
Storage temperature	-20 to 70°C
Humidity	10 to 90% relative. No condensation
Manufacturer	SKIPPER Electronics AS, Norway

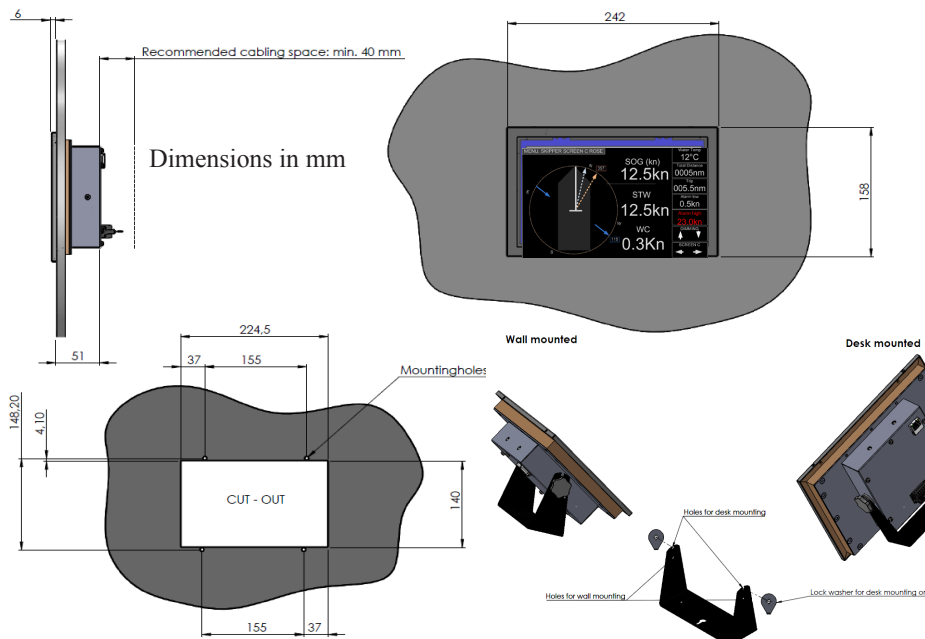

SKIPPER Electronics AS
Enebakkeveien 150
P.O.Box 151, Manglerud

0612 Oslo, Norway
E-mail: sales@skipper.no
Telephone: +47 23 30 22 70
Telefax: +47 23 30 22 71
Co.reg.no: NO-965378847 - MVA
www.skipper.no

All product specifications are subject to change without notice

Date: 2018.02.21



Product Datasheet

JB70D21-SA Electronic Unit for combined DL2 and DL1 Doppler Speed Logs

Specifications

	Part number	Description
Part number	JB70D21-SA	Electronic unit for DL21
Control units	CD402CU-SC CU-M001-SB	DL1 Multi Control unit with LAN DL2 Control unit 9" Touch display
Sensor	DL21SG-SA	1 axis STW and electrical separated 2-axis SOG
JB70D21-SA Package consist of	JB70D21-SA M-KIT-JB70XX	Electronic unit for DL21 Mounting kit for JB70
PCBs inside JB70D21-SA	PP-M001 PI-M001 PC-M001-21	Multi power, PCBM DL1 processor, PCBM DL21 main processor, PCBM
PP-M001 power	115 - 230 V AC/24 V DC max 60 W (For DL2) typ. 15 W 24 V DC max 20 W (for DL1) typ. 10 W	Dual isolated power supply.
PI-M001 interfaces for DL1 Multi	<ul style="list-style-type: none"> NMEA0183, IEC61162-1, 4 output, 1 input Auxiliary x 3 output, 2 input Alarm relay x 1 Analogue 1 x 0-10 V, 1 x 4-20 mA LAN IEC 61162-450 fully implemented. for communication with display module and/or web page setup. 	<ul style="list-style-type: none"> NMEA outputs can be used for IEC61162-2 Auxiliary can be designated to alarm, pulse, speed warning Relay designated to function and/or powerfailure alarm Configurable web pages for setup and runtime functions
PC-M001-21 Interfaces for DL2 in JB70D21	<ul style="list-style-type: none"> NMEA 0183, IEC61162-1, 2 output, 1 input Auxiliary x 2 output, 1 input Alarm relay x 1 2 x LAN IEC 61162-450 	<ul style="list-style-type: none"> Auxiliary can be designated to alarm, pulse, speed warning Relay designated to function and/or powerfailure alarm
IP rating		IP 20
Operating temperature		-15 to 55°C
Storage temperature		-20 to 70°C
Humidity		10 to 90 % relative. No condensation
Weight		1.5 kg
Packaging dimensions / weight		30.5 x 21.5 x 21 cm / 2 kg
Manufacturer		SKIPPER Electronics AS, Norway

Dimensions in mm

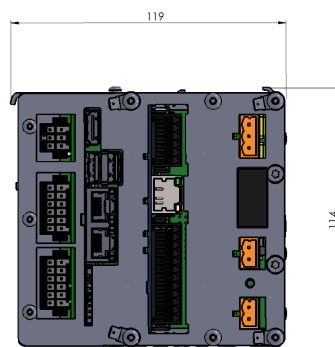
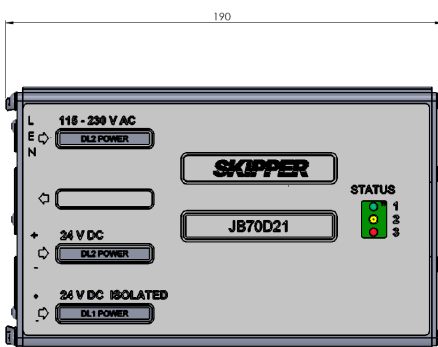

SKIPPER

SKIPPER Electronics AS
Enebakkeveien 150
P. O. Box 151, Manglerud
0612 Oslo, Norway
www.skipper.no
Date: 2019-03-08

All product specifications are subject to change without notice

Product Datasheet

DL21SG-SA Log sensor DL21

For 100mm Sea valve SB-100-XX/DB100-XX

Specifications

Part number	Part number	Description/units
	DL21SG-SA	<ul style="list-style-type: none"> Log sensor DL21 SKIPPER for 100mm Sea Valve 1 Doppler sensor 1-axis STW 1 Doppler sensor 2-axis STW+SOG The 2 sensors mounted in one bottom mounting works independantly and are electrically isolated Designed for ships over 50.000 GRT with simultaneous and independent measurement of speed through water (STW) and speed over ground (SOG)
To be installed into	SB-100-XX DB-100-XX	Sea Valve 100 mm , Single Bottom SST Sea Valve 100 mm, Double Bottom SST
To be used with	JB70D21-XX	Electronic unit
Acoustic frequency range		270-284 kHz (STW+SOG), 710-720kHz (STW)
Bottom detection (SOG)		< 200 m
Cable length		40 m (may be extended or shortened)
Cable diameter		11 mm +/-0.5
Cable minimum bending radius		56 mm
Accuracy		0.2 kn or 2 % whichever is greater
Speed resolution		0.1 kn
Max speed		+45 to - 10 kn Longitudal +/- 25knot Transversal
Temperature accuracy		1 deg
Temperature resolution		0.1 deg
IP rating		IP 68
Operating temperature		-15 to 55°C
Storage temperature		-20 to 70°C
Depth rating		6 bar
Outputs		2 x NMEA (proprietary formats) RS422
Input		2 x NMEA (proprietary formats) RS422
Power input		2 x Nom. 24 V (18 V to 32 V) 16 W
Weight		10.2 kg
Manufacturer		SKIPPER Electronics AS, Norway



45cm * 44cm * 32 cm
10.2kg

137mm

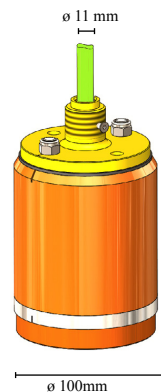

SKIPPER

SKIPPER Electronics AS
Enebakkeien 150
P.O.Box 151, Manglerud
www.skipper.no
Date: 2015-02-23

All product specifications are subject to change without notice

APPENDIX 4: COMMISIONING CHECKLIST

Test Nr	Task	Test to be performed	Checklist	
DL2 – 1	Wire and check the system	Wire together the JB70 LAN and CU-M001 Graphic display	<input type="checkbox"/>	
		• Display does not show 'NO COMMUNICATION'	<input type="checkbox"/>	
DL2 – 2		Set up the config as per instructions	<input type="checkbox"/>	
DL2 – 2	Wire NMEA IN, NMEA OUT	• MFD shows VBW,x.x,y.y,A,x	<input type="checkbox"/>	
		.x,y.y,A,,A,z.z,A , MTW, VLW	<input type="checkbox"/>	
DL2 - 3		Wire Relay output J2 to common alarm	<input type="checkbox"/>	
	• Remove power (AC and DC) and check you see alarm		<input type="checkbox"/>	
DL2 – 4		Install and connect sensor for DL2 to the JB70 unit (J3) Connect JB70 to CU-M001 display Check Sensor	Check Using the service software and the self test in Config – Diagnostic – Self test,	<input type="checkbox"/>
DL2 – 5			• Serial Number of sensor (DL2) should be same as on cable	<input type="checkbox"/>
DL2 – 6	• Firmware version should be correct (3.00 or greater)		<input type="checkbox"/>	
	• Live data should show quality factor (QF) 8 or 9		<input type="checkbox"/>	
		Upgrade firmware to the version on the skipper websites	<input type="checkbox"/>	
DL2 – 9	Install setup in the Bridge Conning system	Check on MFD that you see inputs from DL2	<input type="checkbox"/>	
DL2 - 10		• You can see input VBW, VLW, MTW, occasional VDALR, Check on MFD that you can see the Outputs to the Log	<input type="checkbox"/>	
		• You can see VTG, DPT, GGA, occasional ACK	<input type="checkbox"/>	
DL2 – 11		Check NMEA 1/2 input	<input type="checkbox"/>	
DL2-12		Check on display – Config – Communication, that the input is showing GYRO and GPS information.	<input type="checkbox"/>	
		• Can see HDT/THS, ROT, VTG,GGA/GLL	<input type="checkbox"/>	
		• Can see aft speed on page D	<input type="checkbox"/>	

SKIPPER

SKIPPER Electronics AS
Enebakkveien 150
P. O. Box 151, Manglerud
0612 Oslo, Norway
www.skipper.no

Telephone: +47 23 30 22 70
Telefax: +47 23 30 22 71
E-mail: support@skipper.no
Co. reg. no: NO-965378847-MVA